



EVENTING RULES

25th Edition effective 1st January 202~~2~~¹

Latest update: ~~4 December 2020~~ 07 December 2021

Printed in Switzerland
Copyright © 2018 Fédération Equestre Internationale
Reproduction strictly reserved

Fédération Equestre Internationale

HM King Hussein I Building
Chemin de la Joliette 8
1006 Lausanne
Switzerland

t + 41 21 310 47 47

f +41 21 310 47 60

e info@fei.org

www.fei.org

Contents

PREAMBLE	9
THE FEI CODE OF CONDUCT FOR THE WELFARE OF THE HORSE	10
EVENTING VISION STATEMENT.....	12
Chapter 1 GENERAL	13
500 Introduction	13
500.1 Definition	13
500.2. Responsibility	13
Chapter 2 STRUCTURE OF COMPETITIONS.....	14
501 Competitions and Series	14
501.1 International (CIs)	14
501.2 Official International (CIOs)	14
501.3 Championships (CHs)	14
501.4 Games	15
501.5 FEI Eventing Series	16
502 Formats and Levels	16
502.1 Formats	16
502.2 Levels of difficulty	16
503 Categories	17
503.1 Pony, Junior, Young Rider and U25 Competitions	17
503.2 Age of Athletes	17
503.3 Young Horses Competitions	17
503.4 Age of Horses	18
503.5 Ponies	18
504 Participation Restrictions	18
504.1 Number of Horses per Athlete	18
504.2 Other Participation Restrictions	18
Chapter 3 ADMINISTRATION OF COMPETITIONS	20
505 Expenses, Entry Fees, Prize Money, Responsibility	20
505.1 CIs and CIOs	20
505.2 Championships	20
505.3 Prize Money	20
506 Closed Circuit Television	21
507 Schedule and Results	21
507.1 Schedule	21
507.2 Results	21
508 Invitations	22
508.1 CIs	22
508.2 CIOs	22

508.3 Championships	22
509 Entries	22
509.1 CIs and CIOs	22
509.2 Championships	22
509.3 Certificate of Capability	23
Chapter 4 OFFICIALS.....	24
510 Categories of Officials	24
510.1 Judges	24
510.2 Technical Delegates	24
510.3 Course Designers	24
510.4 Stewards	24
511 Requirements for Officials Transfer	24
511. 1Eventing Stewards specifics	24
512 Requirements for Maintenance of Status	24
513 Appointment of Officials	25
513.1 CCI 1*-Intro (Unified Level)	25
513.2 Short Format (CCIs-S and CCIOs-S)	25
513.3 Long Format (CCIs-L and CCIOs-L)	26
513.4 Ground Jury President Appointment - Additional Requirements	27
513.5 Championships & Games	27
513.6 Veterinarians (please refer to Veterinary Regulations)	28
513.7 Stewards	28
513.8 Appointment Additional Requirements and Restrictions	28
513.9 1, 2 & 3 star Competitions with Several Sections of the Same Level	29
514 Conflict of Interest	29
514.1 Definition - General	29
515 Duties of Officials	30
515.1 Jurisdiction of Officials	30
515.2 Ground Jury	30
515.3 Technical Delegate	31
515.4 Course Designer	32
515.5 Veterinary Delegate/Commission (refer to Veterinary Regulations)	32
515.6 Stewards (Stewarding Team)	32
Chapter 5 TECHNICAL REQUIREMENTS FOR PARTICIPATION.....	34
516 Principles	34
517 Minimum Eligibility Requirement (MER)	34
518 Minimum Eligibility Requirement Validity period	34
518.1 Championships	34
518.2 CIs & CIOs:	34
519 Athletes Categories	35
520 Minimum Eligibility Requirements for CIs and CIOs	35
521 Minimum Eligibility Requirements for Championships & Games	37

522	Reverse Qualification	37
522.1	Reverse Qualification – Horse	37
522.2	Reverse Qualification - Athlete	38
Chapter 6	ATHLETES AND HORSES WELFARE.....	39
523	Athletes Welfare	39
523.1	Medical Information	39
523.2	Medical Fitness	39
523.3	Examination After a Fall	39
523.4	Concussion	39
524	Horses Welfare	39
524.1	Veterinary Examination on Arrival	40
524.2	Horse Inspections	40
524.3	Horse Welfare During the Competition	40
524.4	Appeal	41
524.5	Equine Anti-doping and Controlled Medication Testing	41
525	Dangerous Riding	41
525.1	Definition	41
525.2	Warnings and Penalties	42
525.3	Elimination Before Cross Country	42
526	Abuse of Horse	42
526.1	Definition	42
526.2	Warnings and Penalties	43
526.3	Use of the Whip	43
526.4	Blood on Horses	43
527	Eventing Recorded Warning, Yellow Warning Cards & Suspension	44
Chapter 7	GENERAL COMPETITION RULES.....	45
528	Classification	45
528.1	Individual Classification	45
528.2	Team Classification	45
528.3	Disqualification	46
529	Declaration of Starters	46
530	Substitutions	46
530.1	CIs	46
530.2	CIOs and Championships	46
531	Draw	47
531.1	Approval of Method of Draw	47
531.2	CIs	47
531.3	CIOs and Championships	47
532	Allocation of Starting Positions (CIOs and Championships)	47
532.1	Team Members Positions	47
532.2	Individuals Positions	48
533	Starting Order	48

533.1 CCI-L and CCI-S with order of tests Dressage-Cross Country – Jumping	48
533.2 CCI-S with order of tests Dressage-Jumping-Cross Country	48
533.3 Athletes with multiple rides	48
534 Timetable	49
534.1 Dressage Test	49
534.2 Cross-Country Test	49
534.3 Jumping Test	49
534.4 Minimum Interval Between Tests	49
535 Exercising and Warming Up	49
535.1 Identification Number	49
535.2 Restrictions on Schooling Horses	49
535.3 Exercise Areas	50
535.4 Practice Areas	50
535.5 Warm Up Areas	50
535.6 Dressage Familiarization	50
535.7 Stewarding	51
536 Access to Courses and Arenas	51
536.1 Dressage Arena	51
536.2 Cross Country Course	51
536.3 Jumping Course	51
537 Interruptions and Modifications	51
537.1 Interruptions	51
537.2 Modifications	52
538 Dress	52
538.1 General	52
538.2 Dressage Test	53
538.3 Cross-Country Test	53
538.4 Jumping Test	53
538.5 Inspection of Dress	54
539 Saddlery / Dress	54
539.1 Training and Exercising	54
539.2 Dressage Test	54
539.3 Cross Country and Jumping Tests	55
539.4 Inspection of Saddlery	56
540 Unauthorised Assistance	56
540.1 Exceptions	56
540.2 Receiving Apparatus / Cameras	57
541 Advertising and Publicity on Athletes and Horses	57
541.1 Identification of a Non-Sponsor Manufacturer	57
541.2 Identification of a Sponsor	57
541.3 Use at FEI Championships	57
541.4 Organising Committee Sponsor	58

541.5 Athlete's National Identification	58
541.6 Athlete's Name	58
541.7 National Federation Logo	58
541.8 Advertising in Field of Play	59
541.9 Definition of competition area	59
541.10 (as per General Regulations 135.8)	59
Chapter 8 DRESSAGE TEST	60
542 FEI Dressage Rules	60
543 Administration	60
543.1 Type and level of Test	60
543.2 Number of Tests to be judged by day	60
543.3 Judges Positions	60
544 Scoring	60
544.1 Marking	60
544.2 Calculation of Scores	61
Chapter 9 CROSS COUNTRY TEST.....	62
545 Rules Governing the Cross Country Test	62
545.1 Starting	62
545.2 Optimum Time and Timing	62
545.3 Error of Course	62
545.4 Pace and Dismounting	63
545.5 Overtaking	63
545.6 Athlete in Difficulty	63
545.7 Stopping Athletes	63
545.8 Leaving the Course After Elimination	63
546 Courses	64
546.1 Marking	64
546.2 Distances and Speeds	64
546.3 Finishing Lines	64
546.4 Course Plans	64
547 Obstacles	64
547.1 Definition	64
547.2 Type of Obstacles	64
547.3 Dimensions	65
547.4 Measurement	66
547.5 Obstacles with Elements and/or Options	66
547.6 Number of Jumping Efforts	67
548 Scoring	67
548.1 Faults at Obstacles	67
548.2 Time Faults	67
548.3 Additional Reasons for Elimination	68
549 Definition of Faults	68

549.1 Refusal	68
549.2 Run-out - missing a flag	69
549.3 Circle	69
549.4 Representing After a Disobedience	69
549.5 Fall	70
Chapter 10 JUMPING TEST.....	71
550 FEI Jumping Rules	71
551 Object	71
552 Course and Obstacles	71
552.1 Type of Obstacles	71
553 Scoring	71
553.1 Faults at Obstacles	71
553.2 Time Faults	72
Annexes	73
Annex A Dressage – Annexes	74
1 Permitted Bits for the Dressage Test	74
1.1 Action of Bits	74
1.2 Material:	74
1.3 Permitted Snaffles (see diagrams)	74
1.4 Illegal Bits	75
1.5 Snaffles	75
1.6 Double Bridle	77
2 Permitted Bridles for the Dressage Test	79
3 Dressage Tests for Eventing	80
Annex B Cross Country - Annexes	81
1 Cross Country Obstacles Maximum Dimensions	81
2 Distances - Speeds - Jumping Efforts	81
3 Diagram of Cross Country Obstacles and Faults	82
Annex C Jumping - Annexes.....	83
1 Obstacles Maximum Dimensions - Distances - Speeds - Jumping Efforts	83
Annex D Medical Services.....	84
Annex E Organising Requirements for Eventing 5 star Level Events ...	88
Annex F Athlete Representative.....	90
1 Appointment of Athlete Representative	90
2 Athletes Briefing	90
Annex G FEI Badges for Honour	91
Annex H Rules for Eventing Pony Rider & Events	92
1 International Pony Events and Qualification	92
2 Pony Measurement	92
3 Saddlery	92

CONTENT

4 Dressage Test	92
5 Cross-country Test	93
Annex I Indoor / Arena Cross Country Rules.....	94
1 Rules for National and International competitions	94
2 Prizemoney & expenses	94
3 The FEI Eventing Rules for Horse Welfare / Risk management	94
4 Promotion of Eventing as Discipline	94
GLOSSARY	95

PREAMBLE

These Eventing Rules are effective as of 1 January 2021.

The Eventing Rules will be substantively reviewed every four (4) years unless urgent clarifications or modifications are required for risk management purposes.

As of this date, all other texts of the Eventing Rules or amendments to them dated prior to this date are superseded.

Although these Eventing Rules set out the detailed rules of the FEI for international Eventing Competitions, they must be read in conjunction with any other FEI Rules and Regulations, including but not limited to:

FEI Statutes

FEI General Regulations

FEI Dressage Rules

FEI Jumping Rules

FEI Veterinary Regulations

FEI Eventing Memorandum

FEI Cross Country Guide for Officials

FEI FAQ guidelines on Tack, Equipment and Dress

EADCMR (Equine Anti-Doping And Controlled Medication Regulations)

ADRHA (Anti-Doping Rules for Human Athletes)

The FEI Jumping and Dressage Rules apply for the Eventing Jumping and Dressage Tests except where otherwise provided in these Eventing Rules. Any modification introduced to the FEI Jumping and Dressage Rules during the year will be evaluated for application in Eventing from 1st January the following year.

Every eventuality cannot be provided for in these Eventing Rules. In any unforeseen or exceptional circumstances, it is the duty of the appropriate person or body to make a decision in a sporting spirit, by approaching as near as possible the intention of the Eventing Rules and of the General Regulations. Should there remain any omissions in the Eventing Rules, such omission shall be interpreted in a manner compatible to the fullest extent with the other provisions of these Eventing Rules, other rules and regulations of the FEI, and sporting spirit.

Terms with a capitalized first letter are defined in the Glossary of the Eventing Rules, in the General Regulations, in the Statutes or in other Rules of the FEI.

THE FEI CODE OF CONDUCT FOR THE WELFARE OF THE HORSE

The FEI requires all those involved in international equestrian sport to adhere to the FEI Code of Conduct and to acknowledge and accept that at all times the welfare of the Horse must be paramount. Welfare of the Horse must never be subordinated to competitive or commercial influences. The following points must be particularly adhered to:

1. General Welfare:

a) Good Horse management

Stabling and feeding must be compatible with the best Horse management practices. Clean and good quality forage, feed and water must always be available.

b) Training methods

Horses must only undergo training that matches their physical capabilities and level of maturity for their respective disciplines. They must not be subjected to methods which are abusive or cause fear.

c) Farriery and tack

Foot care and shoeing must be of a high standard. Tack must be designed and fitted to avoid the risk of pain or injury.

d) Transport

During transportation, Horses must be fully protected against injuries and other health risks. Vehicles must be safe, well ventilated, maintained to a high standard, disinfected regularly and driven by competent personnel. Competent handlers must always be available to manage the Horses.

e) Transit

All journeys must be planned carefully, and Horses allowed regular rest periods with access to food and water in line with current FEI guidelines.

2. Fitness to compete:

a) Fitness and competence

Participation in Competition must be restricted to fit Horses and Athletes of proven competence. Horses must be allowed suitable rest period between training and Competitions; additionally rest periods should be allowed following travelling.

b) Health status

No Horse deemed unfit to compete may compete or continue to compete; veterinary advice must be sought whenever there is any doubt.

c) Doping and Medication

Any action or intent of doping and illicit use of medication constitutes a serious welfare issue and will not be tolerated. After any veterinary treatment, sufficient time must be allowed for full recovery before Competition.

d) Surgical procedures

Any surgical procedures that threaten a competing Horse's welfare or the safety of other Horses and/or Athletes must not be allowed.

e) Pregnant/recently foaled mares

Mares must not compete after their fourth month of pregnancy or with foal at foot.

f) Misuse of aids

Abuse of a Horse using natural riding aids or artificial aids (e.g. whips, spurs, etc.) will not be tolerated.

3. Events must not prejudice Horse welfare:

a) Competition areas

Horses must be trained and compete on suitable and safe surfaces. All obstacles and Competition conditions must be designed with the safety of the Horse in mind.

b) Ground surfaces

All ground surfaces on which Horses walk, train or compete must be designed and maintained to reduce factors that could lead to injuries.

c) Extreme weather

Competitions must not take place in extreme weather conditions that may compromise welfare or safety of the Horse. Provision must be made for cooling conditions and equipment for Horses after competing.

d) Stabling at Events

Stables must be safe, hygienic, comfortable, well ventilated and of sufficient size for the type and disposition of the Horse. Washing-down areas and water must always be available.

4. Humane treatment of Horses:

a) Veterinary treatment

Veterinary expertise must always be available at an Event. If a Horse is injured or exhausted during a Competition, the Athlete must stop competing and a veterinary evaluation must be performed.

b) Referral centres

Wherever necessary, the Horse should be collected by ambulance and transported to the nearest relevant treatment centre for further assessment and therapy. Injured Horses must be given full supportive treatment before being transported.

c) Competition injuries

The incidence of injuries sustained in Competition should be monitored. Ground surface conditions, frequency of Competitions and any other risk factors should be examined carefully to indicate ways to minimise injuries.

d) Euthanasia

If injuries are sufficiently severe a Horse may need to be euthanized by a veterinarian as soon as possible on humane grounds, with the sole aim of minimising suffering.

e) Retirement

Horses must be treated sympathetically and humanely when they retire from Competition.

5. Education:

The FEI urges all those involved in equestrian sport to attain the highest possible levels of education in areas of expertise relevant to the care and management of the Competition Horse.

This Code of Conduct for the Welfare of the Horse may be modified from time to time and the views of all are welcomed. Particular attention will be paid to new research findings and the FEI encourages further funding and support for welfare studies.

EVENTING VISION STATEMENT

Eventing constitutes the most complete combined equestrian Competition, demanding of the Athlete considerable experience in all branches of equitation and a precise knowledge of their Horse's ability, and of the Horse a degree of general competence, resulting from intelligent and progressive training.

The Cross Country Test constitutes the most exciting and challenging all-round test of riding ability and horsemanship where correct principles of training and riding are rewarded. This test focuses on the ability of Athletes and Horses to adapt to different and variable conditions of the Competition (weather, terrain, obstacles, footing, etc.) showing jumping skills, harmony, mutual confidence, and in general "good pictures".

This test requires by all involved special awareness and acceptance of a certain level of risk inherent to the particular challenging and exciting nature of the test.

Every effort must be made to ensure that, at each level, responsible Athletes are participating with progressively trained Horses in order not to be exposed to a higher risk than which is strictly inherent to the nature and level of the Competition.

Chapter 1 GENERAL

500 Introduction

500.1 Definition

An Eventing Competition consists of three distinct tests during which an Athlete rides the same Horse throughout, namely: Dressage, Cross Country and Jumping.

500.2. Responsibility

500.2.1. Athletes

An Athlete is ultimately responsible for knowing these Eventing Rules and complying with them. The appointment of a Steward or Official, whether or not provided for in these Eventing Rules, does not absolve the Athlete from such responsibility.

500.2.2. National Federations

National Federations are responsible for selecting and entering eligible Athletes and Horses for all international Competitions taking responsibility for their fitness and competence to compete.

500.2.3. National Safety Officers

All National Federations organising international Eventing Events must appoint an active National Safety Officer (NSO) to liaise with the FEI with regards to all matters directly relating to Eventing Risk Management.

500.2.4. Registration

All Athletes and Horses participating in international Competitions must be annually registered with the FEI.

500.2.5. Horses Passport and Microchips

Please refer to General Regulations (GRs), art 137.

Chapter 2 STRUCTURE OF COMPETITIONS

501 Competitions and Series

501.1 International (CIs)

Competitions with an individual classification. Location, date and level of CIs must be approved by the FEI. Special requirements may apply for 4&5 star level Competitions at new venues.

501.2 Official International (CIOs)

Competitions with an official team and individual classification. Each member of a team will automatically be considered for the individual classification. Teams will always be composed of Athletes from the same country.

Location, date, level and qualifications of CIOs must be approved by the FEI and Eventing Committee. Each National Federation may only organize one Senior CIOs in any calendar year.

501.2.1 Nations Cup

The Nations' Cup (also referred as "NC") is the official international team Competition. Its object is to compare the merit of Athletes and Horses from different NFs and may only be organised on the occasion of a CIO.

"At least three NFs must take part in this Competition for it to be recognised as an FEI Nations Cup™.

If less than five NFs have entered teams for a CCIO, the invitation may be extended to include two teams per NF (including the host team). Before the start of the Event, at the latest at the draw of nations starting order, each NF with two teams must decide which team competes for FEI Nations Cup™ points."

501.3 Championships (CHs)

Competitions with an official team and individual classification. Each member of a team will automatically be considered for the individual classification. Teams will always be composed of Athletes from the same country.

Geographical representation, age group of Athletes and Horses, location, date and level are decided by the Board.

In exceptional cases teams at a Continental Championships may be regional and if so the territorial scope must have been previously approved by the Eventing Committee.

Pony, Junior and Young Rider Championships must be organised during the long school holidays. Junior & YR Championships will preferably be organised jointly.

"All Championships must be organised in the long format at all levels. (Exceptions can be considered by the Eventing Committee)."

501.3.1 Minimum Participation

Continental Championships can only be held if at least three National Federations and/or Regional Teams are represented at the first Horse Inspection.

Outside Europe Continental Championships for Young Riders and Juniors may be held with any number of Regional Teams from at least two National Federations.

501.3.2 Individuals in Addition to Teams

At all Championships and Games, the host country will be limited to the same number of Athletes and Horses as the maximum number permitted for the foreign countries.

At least 3 nations must pass the Horse inspection for this event to be recognised as an FEI Championship (minimum 9 athletes). 90 athletes in the Championship event is the maximum.

The number of individual Athletes authorised to take part in addition to each team is:

- a) Seven or more teams entered - two individuals per country
- b) Five or six teams entered - three individuals per country.
- c) Four or less teams entered - four individuals per country.

National Federations will be advised by the Organising Committee at the closing of nominated entries.

501.3.3 Levels of difficulty

The level of difficulty of Championships will be as follows:

- a) Ponies - CCIP2*-L
- b) Young Horses (six year) - CCI2*-L
- c) Young Horses (seven year) - CCI3*-L
- d) Junior - CCI2*-L
- e) Young Riders - CCI3*-L
- f) Continental/Regional Championships and Games will be decided by the Eventing Committee after consultation with the relevant National Federations
- g) World Championships - please refer to Art. 501.3.4

501.3.4 World Individual and Team Championships

The World Championships are for Seniors.

World Championships can only be held if at least six National Federations are represented.

If the World Championships are conducted separately, the number of Athletes will be in accordance with art. 501.3.2 for Championships.

Participation in World Championships when combined with other disciplines:

- a) Maximum 5 Athletes to take part from one nation.
- b) Maximum of 2 individuals for Nations not represented by a team.
- c) A Team will consist of 3 or 4 Athletes.

Technical Level of World Championships:

- a) 5 star level Dressage and Jumping Test,
- b) Cross-Country Test World CH/Olympic Games level technicality (10min 38-42 efforts)

501.4 Games

501.4.1 Regional and Continental Games

Eventing may be organised at Regional or Continental Multi sport games (e.g. Pan American, Asian, South American, South East Asian, etc.) with an official team and individual classification.

These games are organised by NOC confederations, responsible for general regulations with the exception of the technical aspects. The age group, format and level must be approved by the FEI Eventing Committee.

501.4.2 Olympic Games

Olympic Games are organised by the International Olympic Committee in accordance with the FEI Special Regulations for Olympic Games and current Eventing Rules.

501.5 FEI Eventing Series

FEI Eventing Series can be established further to approval by the Board. (e.g. FEI Eventing World Cup, FEI Eventing Nations Cup, etc.)

For all Series separate Rules for qualification and participation must be approved by the Board.

502 Formats and Levels

Competitions are also defined by their format and level.

502.1 Formats

502.1.1 Definition

Formats define some of the technical aspects of the Competition (duration of the Competition, intensity of the Cross Country Test, order of tests, etc.)

502.1.2 Long Format Competition (CCIs-L)

A Long Format Competition may take place over three or more days. The Dressage Test will be spread over one or more consecutive days, depending on the number of competitors, directly followed on the next day by the Cross Country Test that will be directly followed on the next day by the Jumping Test. When multiple Competitions are running simultaneously a gap day between the Dressage Test and the next Test is permitted, with the approval of the FEI, in order to accommodate the timetable

In the Long Format Competitions the Cross Country course will be of such a length that the Horse is required to be supremely fit and stamina will be required for success.

The Cross Country Test will always take place before the Jumping Test.

502.1.3 Short Format Competition (CCIs-S)

A Short Format Competition may take place over one or more days. The Dressage Test will always take place first and will be followed on the same or following days by the Jumping and Cross Country Test. When multiple Competitions are running simultaneously a gap day between the Dressage Test and the next Test is permitted, with the approval of the FEI, in order to accommodate the timetable

In the Short Format Competition the level of difficulty of the Cross Country course is similar to the Long Format according to the star system, but the course is shorter and the intensity of efforts will be higher.

The Cross Country Test will preferably take place after the Jumping Test.

502.1.4 Unified format Competition (CC1*-Intro)

CCI1*-Intro may take place as a Short or Long format as to the order of tests and Horse Inspection requirements.

502.2 Levels of difficulty

The levels indicate the degree of difficulty of the Competition and are defined by a progressive star system ranging from the lower level one star to the higher 5 star.

The Five star level Competitions require the maximum level of training and experience from both Athlete and Horse.

503 Categories

503.1 Pony, Junior, ~~and~~ Young Rider and U25 Competitions

Pony, Junior, ~~and~~ Young Riders and U25 Competitions may be organised according to the age group of the Athletes.

503.1.1 Pony Competitions

An Athlete may compete as a Pony Rider from the beginning of the calendar year in which the Athlete reaches the age of 12 until the end of the year in which the Athlete reaches the age of 16.

A Pony Rider may compete in Eventing Competitions not limited to Ponies if appropriately qualified without losing their status as a Pony Rider.

503.1.2 Junior Competitions

An Athlete may compete as a Junior from the beginning of the calendar year in which the Athlete reaches the age of 14 until the end of the calendar year in which the Athlete reaches the age of 18.

503.1.3 Young Rider Competitions

An Athlete may compete as a Young Rider from the beginning of the calendar year in which the Athlete reaches the age of 16 until the end of the calendar year in which the Athlete reaches the age of 21.

503.1.4 U25 Competitions

An Athlete may compete in the U25 category from the beginning of the calendar year in which the Athlete reach the age of sixteen (16) until the end of the calendar year in which the Athlete reach the age of twenty five (25).

503.2 Age of Athletes

An Athlete is considered a Senior from the beginning of the calendar year in which the Athlete reaches the age of 18.

Championships and Games are limited to senior Athletes unless specifically organised for Juniors, Young Riders or Pony Riders.

International Competitions are limited to Senior Athletes unless specifically organised for Junior, Young Riders or Pony Riders with the following exceptions:

- a) With the express permission of their National Federation, an Athlete may compete in a three star Competition from the beginning of the calendar year in which the Athlete reaches the age of 16.
- b) With the express permission of their National Federation, an Athlete may compete in a two star level Competition from the beginning of the calendar year in which the Athlete reaches the age of 14.
- c) With the express permission of their National Federation, an Athlete may compete in a one star level Competition from the beginning of the calendar year in which the Athlete reaches the age of 12.

503.3 Young Horses Competitions

Young Horses Competition may be organised according to the age of Horses for six and seven year old Horses.

Such Competitions may only take place at CCI2* & 3*- Long or Short.

503.4 Age of Horses

The following minimum age of Horses will apply for all Competitions.

- a) CCI1* Level Competitions: a Horse may compete in 1* Competitions from the beginning of the calendar year in which the Horse reaches the age of five
- b) CCI2*/3* level Competitions: a Horse may compete in 2*, 3* Competitions from the beginning of the calendar year in which the Horse reaches the age of six.
- c) CCI4*level Competitions: a Horse may compete in Competitions of four star level from the beginning of the calendar year in which the Horse reaches the age of seven.
- d) CCI5*level Competitions and Four star Level Championships: a Horse may compete in Competitions of five star level or four star Championship from the beginning of the calendar year in which the Horse reaches the age of **eight**.

503.5 Ponies

503.5.1 Definition

For the definition of a Pony and the Pony measuring protocol, refer to Veterinary Regulations.

503.5.2 Age of Pony

A Pony may compete in Pony Competitions from the beginning of the calendar year in which the Pony reaches the age of six.

Except for the specific Competitions limited to Ponies, all international Competitions are open equally to Horses and Ponies, providing the Ponies and their Athletes meet all relevant qualifications.

504 Participation Restrictions

504.1 Number of Horses per Athlete

504.1.1 Championships and Games

An Athlete may only ride one Horse.

504.1.2 CIOs

An Athlete may ride only one Horse as a member of a team and may ride in only one team.

The Team competition must be included in the Dressage and Cross country starting lists as a block. Individual athletes will be included as a separate block preferably before the Team block or after according to the OC decision. This information will be included in the schedule

504.1.3 CIs

There is no limitation to the number of Horses an Athlete may ride in an Individual Competition, with the following exceptions:

- a) The Organising Committee may impose a balloting procedure, in its absolute discretion, whether for time-tabling or any other reason. Such a procedure must be published in the schedule of the Competition.
- b) If a Competition has more entries than it can accommodate, no Athlete may ride more than two Horses (or one Horse if so decided by the Organising Committee).

National Federations are anyway responsible, in entering Athletes in international Competitions, to ensure that no Athlete rides more Horses than their abilities in any one day of Cross Country.

504.2 Other Participation Restrictions

504.2.1 One and Two star Level Competitions

A Horse that has obtained a Minimum Eligibility Requirement at W-CH/OG/5*-L level Competition

in the current or preceding year may not be entered in a CCI1* or CCI2* Long or Short Competition unless the Athlete is non-categorised.

504.2.2 Championships

Athletes and Horses may only take part in either a Pony, Junior, Young Rider or Senior Championship in any calendar year. This provision does not apply to Championships for Young Horses.

504.2.3 Junior Championships

Junior Championships are open to all Horses except those which have obtained a MER in CCI5*-L Competition or at the Olympic Games or W-CH during the preceding or current year.

Once an Athlete has taken part in an Eventing Championship for Seniors or in Eventing at a Regional or Olympic Games, the Athlete can no longer go back to an Eventing Junior Championship.

Chapter 3 ADMINISTRATION OF COMPETITIONS

505 Expenses, Entry Fees, Prize Money, Responsibility

505.1 CIs and CIOs

The entry fee and expenses to be offered is at the discretion of the Organising Committee.

All Athletes from the host country, including foreign Athletes resident in the host country, must be offered the same allowances.

All other foreign Athletes must be offered the same allowances that may be different from the one offered to national or resident foreign Athletes.

505.2 Championships

505.2.1 Continental Championships

The Organising Committee is responsible for organising and covering the expenses for quarantine and customs duties (if applicable) including agent and veterinary fees for entering and leaving the border of the organising country and/or the show grounds.

The Organising Committee has then the option to:

- a) Request a reasonable entry fee for Individuals and/or Teams and additionally provide the following from the day before the first Horse Inspection until the day after the Jumping Test:
 - a. living expenses for Athletes, Grooms, Chef d'Equipes and Team Veterinarian (accommodation, food and local transportation)
 - b. stabling, bedding and fodder for the Horses
- b) Waive the entry fee and not meet the additional expenses. In this case, the Organising Committee is not obliged to provide neither living expenses nor stabling and fodder for the Horses.

For Junior, Young Rider, and Senior Championships an entry fee may be charged only if prize-money is awarded.

505.2.2 World Championships

The entry fee and expenses to be offered for World Championships will be according to FEI agreement with the Organising Committee.

505.2.3 Responsibility

Chefs d'Equipe are responsible to be present and represent their athletes at all Official Chef d'Equipe meetings.

The Chefs d'Equipe are responsible for the behaviour of their teams and/or individuals throughout the Event. They and their National Federation are responsible for any damages that occur. If the Athletes are not lodged in private homes, the Chefs d'Equipe must stay with their teams and/or individuals.

The Ground Jury has the authority to assess any costs for damages. According to the FEI legal system, the Ground Jury may impose a fine and has the right to disqualify the team and/or individuals with unacceptable behaviour at any stage throughout the Event.

505.3 Prize Money

505.3.1 Distribution

The total amount of prize-money published for each Competition in the schedule must be distributed as per the breakdown shown for each Competition in the schedule.

Organising Committees must state the details of the distribution of prizemoney in the Event schedule. Organising Committees may include two prizemoney distribution options in the schedule to enable the amount and number of prizes to be adjusted to the definite number of starters.

The minimum number of prizes offered for each Competition must be allocated on the basis of one prize for every commenced four Athletes (Dressage starters), with a minimum of five prizes.

If less than five Athletes complete the Competition, the minimum number of prizes to be distributed shall be amended to equal the number of Athletes completing.

The value of the first prize for individuals, either in cash or in kind easily convertible into cash, may never exceed one third of the total value of the prize money and prizes convertible into cash offered for the Competition.

505.3.2 Competitions with several Sections

Prize Money must be the same for each section and must be specified in the Schedule.

505.3.3 Pony Competitions

Prize money is not allowed at Pony Competitions.

505.3.4 Prize-giving

Prize winners must take part in the prize giving ceremony and should do so with the placed Horses (however if Cross Country takes place as last test, horses are not required to take part).

The Organising Committee must officially inform competitors of the prize giving protocol and the number of prize winners required to take part in the ceremony.

If a prize winner fails to take part at the prize giving ceremony, without plausible excuse and notification to the Organising Committee, the Ground Jury, at its discretion, may decide to allow the Organising Committee to withhold the Athlete's prize.

506 Closed Circuit Television

The provision of closed circuit television of the Cross Country Test in the Athlete enclosure close to the start and at the Control Centre for the use of the Ground Jury and Cross Country Controller is mandatory for all Five Star level Competitions (CCI5*-L star) and four and five star level Championships (CH 4&5 star).

507 Schedule and Results

507.1 Schedule

For all Competitions the schedule of the Competition drafted in the form prescribed by the FEI must be sent to the FEI for approval at the latest:

- a) Four weeks before the Competition for CCI1*-Intro, CCI2* & 3* Long or Short level
- b) Ten weeks before the Competition for CCI4* Long or short, CCI5* Long, CCIOs and CH all levels.

Failure to respect the above deadlines will be dealt according to the General Regulations provisions.

No Schedule can be approved after the closing date of the entries.

507.2 Results

Full result of the Competitions must be forwarded to the FEI by the Organising Committee preferably immediately at the end of the Event and up to a maximum of two days after the Event is finished according to the electronic format described by FEI.

Failure to respect the above deadline will be dealt according to the General Regulations provisions.

508 Invitations

All invitations must be sent to National Federations and not to individual Athletes.

508.1 CIs

The National Federations to be invited, and the number of Athletes and Horses per country, are at the discretion of the Organising Committee.

One groom per Athlete must be invited.

508.2 CIOs

At least five foreign countries must be invited. The number of Athletes from the host country is unlimited.

The Organising Committee may only restrict the number of nations to be invited with the agreement of the Secretary General and the Eventing Committee.

One groom per Athlete and one Official per country must be invited.

508.3 Championships

Championships are open to all eligible Athletes and Teams. Invitations must be sent to all eligible National Federations.

One groom per Athlete and two Officials per country must be invited.

509 Entries

509.1 CIs and CIOs

Entries must be made by the National Federations according to the conditions published by the Organising Committee in the approved schedule of the Competition.

509.1.1 Definite Entries

Definite Entries must be made at the latest four (4) days preceding the beginning of the Event. These represent the final selection of Athletes and Horses that may participate in the Event. Substitutions of Athletes and/or Horses may be only made in accordance to these rules.

509.2 Championships

Entries for FEI Championships and FEI World Equestrian Games must be made in accordance with the FEI General Regulations art. 116.2.

Entries must be made by the National Federations in two phases as follows.

The exact dates by which entries must be received will be published in the approved schedule of the Competition.

509.2.1 Nominated Entries

At latest four weeks before the Competition each National Federation, that has made an entry in principle, including the host National Federation:

- a) May enter through the FEI Online Entry System, up to three times the number of Horses and Athletes that are entitled to start. Within this limit, there is no restriction on the number of Horses that may be entered for each Athlete.

- b) Must include the registration number for all nominated Athletes and the Horses registration and passport number if not entered through the FEI online entry system.

509.2.2 Definite Entries

At the latest four days before the first Horse Inspection of the Competition the definite entries must be validated through the FEI Online Entry System.

Each National Federation must choose from its list of nominated entries and confirm up to the maximum of its entitlement of starters.

These are the Athletes and Horses that will travel to the Competition.

After the definite entries have been sent in, substitutions of Athletes and/or Horses from the list of nominated entries may only be made with the express permission of the Organising Committee, but never less than two hours preceding the first Horse Inspection.

509.3 Certificate of Capability

For all Championships and Games, National Federations must download their Certificate of Capability through the FEI Online Entry System, and send a signed version to the FEI declaring that their Athlete and Horse have fulfilled their national requirements and reached FEI requirements by the date of the nominated entries or a different date set by the FEI.

Chapter 4 OFFICIALS

Code of Conduct for Officials

All FEI Officials are bound by the FEI Code of Conduct (refer to General Regulations Annex H).

510 Categories of Officials

510.1 Judges

International Judges are divided into two categories:

- a) Level 2 Judges
- b) Level 3 Judges

510.2 Technical Delegates

International Technical Delegates are divided into two categories:

- a) Level 2 Technical Delegates
- b) Level 3 Technical Delegates

510.3 Course Designers

International Course Designers are divided into two categories:

- a) Level 2 Course Designers
- b) Level 3 Course Designers

510.4 Stewards

Stewards are divided into three Levels:

- a) Level 1
- b) Level 2
- c) Level 3

511 Requirements for Officials Transfer

The Eventing Committee will review the Eventing Officials Education System on a yearly basis to ensure the best practice standards. All updates will be published on the FEI website in the beginning of each calendar year.

Transfer requests must be clearly documented by the National Federation responsible in accordance with the published requirements. .

511.1 Eventing Stewards specifics

All FEI listed Judges and Technical Delegates will automatically be listed as Level 1 FEI Stewards.

512 Requirements for Maintenance of Status

Note: The Eventing Education System documents provide details on the requirements on the maintenance of FEI Officials status.

Officials not fulfilling the Eventing Official Education system requirements will be transferred down or dropped from the Eventing Officials list at the discretion of the Eventing Committee.

513 Appointment of Officials

Officials will be appointed by the FEI or by the Organising Committee according to the different types and level of Competitions and in accordance with the following tables.

National Officials can only be appointed for CCI1*, 2* and 3* if specifically mentioned in the tables below. If National Officials are appointed, these must be from the Host country (except for Assistant Technical Delegate, Assistant Course Designer & Assistant Steward providing they have insurance coverage) unless directly appointed by the FEI for the purpose of an Educational Program.

Note: For events with several competitions/sections, Organising Committees can offer alternative composition of Officials to the requirements listed in the below tables and/or provisions in Art 513.9 with the objective to reduce costs. Such proposals shall be provided with the Schedule and approved by FEI HQ.

To ensure that International standards are respected, proposals must comply with the following minimum requirements:

- a) For the overall event, a minimum of one International Official shall be appointed for each category of Officials (Judge, TD and Course Designer) of the level of the highest competition organised. These Officials will be responsible and will report back to FEI on the overall event.

Such provision does not apply for Championships and Games of any level.

513.1 CCI 1*-Intro (Unified Level)

	CCI1*-Intro
	<u>2 or 3 Judges</u>
Ground Jury	<u>All Judges can be host country national Judges if FEI TD appointed from FEI level 2 or 3 list</u>
Technical Delegate	<u>TD from FEI level 2 or 3 list (or national TD if one FEI level 2 or 3 Judge appointed)</u> <u>Foreign requirements not compulsory</u>
Course Designer	<u>Can be national CD</u>
Jumping Course Designer	<u>Jumping CD from National list recommended</u>
Veterinary Delegate	<u>FEI Official Veterinarian in accordance with the Veterinary Regulations</u>
Veterinary Services Manager (VSM)	<u>From FEI list of Level 1 Official Veterinarians</u> <u>Treating Veterinarian(s), Veterinary Control Officer and/ or Course Veterinarian(s), as required</u>
Chief Steward	<u>Level 1, 2 or 3 Eventing Steward</u>

513.12 Short Format (CCIs-S and CCIOs-S)

Short format competition	4 star	3 star	2 star
Ground Jury	2 or 3 Judges		
	All Judges from FEI level 2 or 3 lists with a minimum of one Judge from Level 3 list	Minimum one Judge from FEI level 2 or 3 lists	
Technical Delegate	TD from FEI Level 3 list	TD from FEI level 2 or 3 list	
	Either Foreign TD or Foreign Member of GJ compulsory	Foreign requirement not compulsory	

AUS & NZL Exceptional case only for cost reasons	Foreign requirement not compulsory, however 2 Judges, TD and CD must be from Level 3 list		
Course Designer	CD from FEI Level 3 lists	CD from FEI level 2 or 3 list	Can be national CD
Jumping Course Designer	Jumping CD from National List	Jumping CD from National list recommended	
Veterinary Delegate	FEI Official Veterinarian(s) in accordance with the Veterinary Regulations.		
Veterinary Services Manager (VSM)	From FEI list of Level 1 Official Veterinarians Treating Veterinarian(s), Veterinary Control Officer and/ or Course Veterinarian(s), as required		
Chief Steward	Level 2 or 3 Eventing Stewards	Level 1,2 or 3 Eventing Steward	
<u>Assistant Stewards</u>	<u>At least one level 1 Eventing Stewards</u>	<u>National Assistant Stewards</u>	

513.23 Long Format (CCIs-L and CCIOs-L)

Long format competition	5 star	4 star	3 star	2 star
Ground Jury	3 Judges		2 or 3 Judges	
	All Judges from FEI Level 3 lists	Minimum of two Judges Judge from FEI Level 3 list	Minimum one Judge from FEI level 2 or 3 Lists	
	Foreign member of GJ compulsory		Foreign Official compulsory (either GJ, TD or CD)	
Technical Delegate	TD from FEI Level 3 list		TD from FEI level 2 or 3 lists	
Course Designer	CD from FEI Level 3 lists		CD from FEI Level 2 or 3 list	CD may be national
Jumping Course Designer	Jumping CD from FEI 3&4 Jumping list	Jumping CD from National List	Jumping CD from National list recommended	
Veterinary Delegate	FEI Official Veterinarian(s) in accordance with the Veterinary Regulations.			
Veterinary Services Manager	From FEI list of Level 1 Official Veterinarians Treating Veterinarian(s), Veterinary Control Officer and/ or Course Veterinarian(s), as required			
Chief Steward	Level 2 or 3 Eventing Steward		Level 1,2 or 3 Eventing Steward	
<u>Assistant Stewards</u>	<u>At least one level 1 Eventing Stewards</u>		<u>National Assistant Stewards</u>	

~~513.3 CCI 1* Intro (Unified Level)~~

	CCI1* Intro
	2 or 3 Judges
Ground Jury	All Judges can be host country national Judges if FEI TD appointed from FEI level

	2 or 3 list
Technical Delegate	TD from FEI level 2 or 3 list (or national TD if one FEI level 2 or 3 Judge appointed) Foreign requirements not compulsory
Course Designer	Can be national CD
Jumping Course Designer	Jumping CD from National list recommended
Veterinary Delegate	FEI Official Veterinarian in accordance with the Veterinary Regulations
Veterinary Services Manager (VSM)	From FEI list of Level 1 Official Veterinarians Treating Veterinarian(s), Veterinary Control Officer and/ or Course Veterinarian(s), as required
Chief Steward	Level 1, 2 or 3 Eventing Steward

513.4 Ground Jury President Appointment - Additional Requirements

- a) The FEI Judge (Level 2 or Level 3) must be appointed as President of the Ground Jury if there is a national Judge as second Judge.
- b) For 4&5 star Competitions the FEI Level 3 Judge must be appointed as President of the Ground Jury.

513.4.1 CCI5*-L

The Ground Jury and Technical Delegate for 5 star events will be appointed by the Organising Committee in consultation with the FEI according to requirements set by the Eventing Committee and published on the FEI Website.

The Ground Jury, Technical Delegate and Course Designer must be selected from the FEI Level 3 Lists.

513.5 Championships & Games

Championships & Games	W-CH & Olympic Games	4 star	3 star	2 star
Ground Jury	3 Judges from FEI Level 3 list			
	Minimum one Foreign GJ member			
	Jumping Judge from FEI list is compulsory			
Technical Delegate	TD from FEI Level 3 list			
Course Designer	CD from FEI Level 3 list			
Jumping Course Designer	Jumping CD from 3&4 FEI Jumping list	Jumping CD from national list		
Veterinary Commission	Foreign Veterinary Delegate and additional Veterinary delegate in accordance with the Veterinary Regulations			
Veterinary Services Manager (VSM)	From FEI list of Level 1 Official Veterinarian Treating Veterinarian(s), Veterinary Control Officer and/ or Course Veterinarian(s), as required			
Chief Steward	Level 3 Eventing Stewards list	Level 2 or 3 Eventing Steward		

513.5.1 Championships and Games

The Ground Jury, Foreign Technical Delegate will be appointed by the FEI in consultation with the Organising Committee. All Eventing Officials must be selected from the FEI Level 3 list. The Veterinary Commission and/or Foreign Veterinary Delegate will be appointed in accordance with the VRs

513.6 Veterinarians (please refer to Veterinary Regulations)

513.7 Stewards

513.7.1 FEI Chief Steward

For each Event a Chief Steward must be chosen from the FEI list of Stewards and appointed by the Organising Committee to be responsible for all Stewarding matters related to that Event. The Chief Steward is a key member of the team of Officials working with the Technical Delegate and Organising Committee.

513.7.2 Assistant Stewards

According to the size (number of overall competitors at the Event) and type of Event, a sufficient number of Assistant Stewards must be appointed by the Organising Committee in consultation with the Chief Steward.

All Assistant Stewards at international Events should preferably hold at least a Level 1 status. If this is not the case they must have received formal instruction in their specific responsibility from the Chief Steward.

At CCI 4&5*-L (Long) format international Events, Assistant Stewards to whom important tasks such as warm-up arenas, boot and bandage control, stable duties are allocated, must hold at least a Level 1 status.

513.8 Appointment Additional Requirements and Restrictions

513.8.1 Ground Jury

The same combination of members of a Ground Jury may not be appointed for two (2) consecutive years or three (3) consecutive Events at the same venue.

No Judge may serve as a member of a Ground Jury at more than five (5) CCI-L at 4* and 5* Star level events in any calendar year.

513.8.2 Technical Delegates

A Technical Delegate cannot officiate at the same venue for more than three (3) consecutive years or four (4) consecutive Events.

A Technical Delegate cannot officiate at more than five Long Format Competitions in any calendar year.

513.8.3 Number of Technical Delegates per Event

In the case of more than one Competition (international and national) at the same Event:

- a) One Technical Delegate must be appointed for two Competitions.
- b) Two Technical Delegates must be appointed in the case of three or four Competitions.
- c) Three Technical Delegates must be appointed in the case of five Competitions or more.

In the case of an Event with 100 or less competitors in no case more than two Technical Delegates are required.

Additional appointed Technical Delegates can be national Technical Delegates.

Different sections are considered to be the same Competition.

In case of more than one Technical Delegate appointed at the same Event, one overall Technical Delegate must be selected. The Technical Delegate will be responsible for coordinating the job

of the Technical Delegates and the reporting to the FEI for the whole Event.

513.8.4 Assistant Technical Delegate

An Assistant Technical Delegate must be appointed by the Organising Committee for all Games, Championships, Series Finals, CIOs and 4&5 star level CCIs and may be appointed at other international Competitions.

The Assistant Technical Delegate may be selected from the FEI lists or may be a national Technical Delegate.

At Games, Championships, Series Finals and 5 star level Competitions the Assistant Technical Delegate must be of a different nationality to the Technical Delegate.

513.8.5 Balance of Experience and Expertise

For C Is at 4&5 star level in special circumstances, the FEI has the right, in a timely manner, to consult with the Organising Committee and ask for a different balance of experience and expertise within the team of Officials proposed in the schedule of the Competition.

513.9 1, 2 & 3 star Competitions with Several Sections of the Same Level

One, two and three star Competitions can be divided in several sections of the same level and be treated as a single entity according to specific provisions.

If several sections of Competitions at the same level are organised, the whole Competition will be treated as a single entity and Officials will be appointed as follows:

- a) Where there is more than one section of an Event, it is possible to appoint only one Ground Jury for the Event, consisting of a President and one or two members who will be responsible for all decisions common to the various sections.
- b) Additional Judges will be appointed to assist in the judging of the Dressage Test, if necessary to make up the Horse Inspection panels and if required, to help judge the Jumping Test. These additional Judges may be taken from the FEI lists of Officials, Level 3 or Level 2 Judges or may be national Judges.
- c) At a Long Format Competition (CCIs-L), at least one member of the Ground Jury must officiate at each Horse Inspection. All Horses in any section must be inspected by the same Veterinarian and Ground Jury member at all inspections.
- d) There must be only one Technical Delegate to officiate in all sections of an Event organised at the same star level.
- e) The Ground Jury must consist of members selected by the Organising Committee in accordance with the rules for the relevant star level.

514 Conflict of Interest

514.1 Definition - General

A substantial appearance of a conflict of interest exists whenever an individual involved in any capacity with the FEI is involved in or perceived to be involved in multiple interests, one of which could possibly influence, or is perceived to influence, the motivation for an act in the other.

A conflict of interest is defined as any personal, professional or financial relationship, including relationships of family members that could influence or be perceived to influence objectivity when representing or conducting business or other dealings for or on behalf of the FEI.

Conflicts must be avoided whenever practicable. However, conflicts may be linked to experience and expertise that is necessary to qualify Officials.

The specific balance between conflict and expertise shall be regulated by the relevant Sport Rules.

515 Duties of Officials

The Ground Jury, Technical Delegate(s), Course Designer and Veterinary Delegate, in conjunction with the Organising Committee, shall endeavour to ensure that all the arrangements for the Competition are fair, safe and appropriate.

This shall include the arenas, courses, obstacles and footing with special regard to the level of difficulty of the Cross Country and Jumping courses that must in all cases fully respect the level of the Competition.

Ensuring the correct level of difficulty of the Cross Country and Jumping courses according to the relative star level of the Competition is paramount in order to achieve a correct and effective technical progression of Horses and Athletes throughout the levels.

515.1 Jurisdiction of Officials

The period of jurisdiction of the Ground Jury commences one hour before the beginning of the first Horse Inspection or one hour prior to the start of the Dressage Test, whichever is earlier, and terminates half an hour after the announcement of the final results.

However, the Ground Jury has full jurisdiction also from when they inspect and approve the cross country course

515.2 Ground Jury

515.2.1 General Duties

The Ground Jury is ultimately responsible for the judging of the Competition and for settling all problems that may arise during its jurisdiction.

Any member of the Ground Jury shall have the duty and full authority at any time during the Competition to eliminate from the Competition any Horse that is lame, sick or exhausted and any Athlete that is unfit to continue.

The Ground Jury will also be responsible for monitoring and taking action in any case of dangerous riding (art. 525) and abuse of Horse

515.2.2 Inspection and Approval of Courses

The Ground Jury inspects and approves the Cross Country and Jumping courses with the Technical Delegate and the Course Designer.

If, after consultation with the Technical Delegate, the Ground Jury is not satisfied with the courses, it is authorised to modify them.

515.2.3 Horse Inspection

The Ground Jury will conduct the first and second Horse Inspections with the Veterinary Delegate.

515.2.4 Dressage Test

The Ground Jury will judge the Dressage Test.

515.2.5 Cross Country Test

The Ground Jury will be responsible for determining objections against decisions by technical personnel, including Fence Judges and Timekeepers, on the Cross Country Test and may substitute their judgement for that of any Judge or Official, whether in favour of the Athlete or not.

During Cross Country either the President of the Ground Jury must be in Cross Country Control or, if the President of the Ground Jury does not speak or understand the language which is being used for communication purposes, one of the members of the Ground Jury who does speak and understand the language must be there instead.

The President, in consultation with the Technical Delegate, shall make this decision and will decide about the role and positioning of the other Ground Jury members during the Cross Country Test.

The President and the members of the Ground Jury shall retain the same task throughout the Cross Country Test.

515.2.6 Jumping Test

The Ground Jury will be responsible for the judging of the Jumping Test.

At all Games and Championships the Ground Jury must be assisted by a Jumping Judge from the FEI list.

At all other Events such assistance is optional. Should any member of the Ground Jury be also a qualified Jumping Judge, no additional member is required.

It is essential that the President of the Ground Jury or appointed Jumping Judge be in control of the bell.

At Short Format Competitions (CCI-S), if the Jumping takes place while other phases are also happening, this task may be delegated to a qualified national Jumping Judge with an understanding of FEI rules.

515.3 Technical Delegate

515.3.1 General Duties

The Technical Delegate will approve the technical and administrative arrangements for the conduct of the Competition including examinations and inspections of Horses, accommodation of Horses and Athletes, stewarding of the Competition, liaison with the Chief Medical Officer in regard to the Medical plan as well as the implementation of the Serious Incident Management Protocol.

The authority of the Technical Delegate shall be absolute until the Technical Delegate has reported to the Ground Jury that the Technical Delegate is satisfied with all the arrangements. Thereafter, the Technical Delegate will continue to supervise the technical and administrative conduct of the Event and will advise and assist the Ground Jury, Veterinary Commission and the Organising Committee.

515.3.2 Courses and Arenas

For all three tests the Technical Delegate will inspect and approve the courses, arenas and facilities for exercising and training, including the type and dimensions of obstacles and measurements of courses, with particular reference to their suitability for the level of the Competition.

The Technical Delegate is specifically required to measure all courses to ensure they are of the indicated distances. The Technical Delegate must be able to inspect the courses early enough to allow for modifications to be made.

The Technical Delegate will supervise the briefing and conduct of all technical personnel (i.e. fence Judges, timekeepers).

515.3.3 Instruction to Officials

Where there is any doubt as to the correct interpretation of the rules of judging any element, obstacle or combination of obstacles, it is recommended that the Technical Delegate, in consultation with the Ground Jury if possible, should approve the instructions to the Officials, providing a rough sketch if necessary, and all Athletes will be informed at the briefing or as soon as possible after the Technical Delegates decision, if later.

515.3.4 Scoring

The Technical Delegate will investigate all enquiries regarding scoring, including penalties awarded, and report to and advise the Ground Jury on any decisions they are required to make.

The Technical Delegate shall be responsible for signing off the final results of the Competition(s).

515.3.5 Abuse of Horse and/or Dangerous Riding

The Technical Delegate has the authority to warn or stop an Athlete on Cross Country course for dangerous riding (art. 525), riding an exhausted Horse, excessive pressing of a tired Horse, riding an obviously lame Horse, excessive use of whip and/or spurs (art. 526).

515.3.6 Reporting to the FEI

The Technical Delegate is responsible for reporting back to FEI Headquarters within 10 days following the end of the Event.

515.4 Course Designer

All Course Designers designing a 4 or 5 star course for the first time must be mentored and shadowed by an experienced Course Designer at the same level

The Course Designer must be present at the Cross Country course inspection with the specific Ground Jury for the Cross Country course for which the Course Designer is responsible. If for any serious reason, the appointed Course Designer cannot be present also during the Cross Country Test, this information needs to be reported to the FEI with a proposal for replacement before the start of the Event.

Any infringement of this article will be reported to the FEI Secretary General ~~for possible legal action to be considered by the FEI.~~

515.4.1 Cross Country

The Course Designer is responsible for the layout, measurement, preparation and marking of the route for the Cross Country and for the design, construction and marking of the obstacles on Cross Country.

The Course Designer role during the Cross country test is to work with the Technical Delegate and Ground Jury to deal with judging queries, sanctions (dangerous riding, abuse of horse, incorrect behaviour, welfare of the horse), reviewing of course/fences during XC in case of repetitive falls or weather situations.

The Course Designers are responsible to ensure that all frangible technology are fitted in accordance to the rules & up to date guidelines.

515.4.2 Jumping

The Course Designer is ultimately responsible for the layout, design and construction of the Jumping course and the Course Designer must ensure that the course complies with all the current Eventing Rules.

The duty of building the Jumping course will be eventually be delegated to a Jumping Course Designer according to tables in Art 513.

515.5 Veterinary Delegate/Commission (refer to Veterinary Regulations)

515.6 Stewards (Stewarding Team)

The duties of the Stewarding team is to assist the Organising Committee, Ground Jury, Technical Delegate and Athletes in the conduct of the Competition according to the FEI Rules, paying due respect to the guidelines defined in the Code of Conduct for Welfare of the Horse and that a level playing field is provided for all Athletes participating in the Event.

During the three days before the start of the first Horse Inspection or the Dressage Test, as applicable, the Stewarding team are responsible for the application of the FEI rules.

Specifically, but not exclusively, their duties cover planning and supervision of work in all exercise, practice, warm-up, and stable areas, checking of dress and saddlery, assistance with

Horse examinations and Inspections, and will be involved in the Medication control of Horses (EADCMR) and for Athletes (ADRHA) if required. They are expected to work closely with the Organising Committee, Athletes, Technical Delegates and other Officials.

Chapter 5 TECHNICAL REQUIREMENTS FOR PARTICIPATION

516 Principles

In order to be entered in an international Competition Athletes and Horses must first and foremost fulfil the criteria set by their National Federation.

In addition to the criteria set by National Federations the eligibility to compete will be determined by the achievement of a number of Minimum Eligibility Requirements (art. 517) in international Competitions. MERs have to be achieved by the Horse or by the Athlete/Horse as a combination according to the level of competence/experience (Art. 519 Athletes Categories) of the Athlete and the level of the Competition.

National Federations are encouraged to set stronger and additional criteria to FEIs minimum requirements for Horses and Athletes.

Organising Committees, with the approval of the FEI and their own National Federation, may also impose additional criteria for Horses and/or Athletes, which must be published in the schedule approved by the FEI.

The Technical Delegate, or their nominee, shall check that all Horses and Athletes are correctly entered by their National Federation and registered with the FEI.

517 Minimum Eligibility Requirement (MER)

A Minimum Eligibility Requirement is achieved by completing a Competition within minimum parameters of all round performance as follows:

- a) Dressage Test: not more than 45 penalty points (or 55%).
- b) Cross Country test:
 - Cross Country Test: A clear round at obstacles (activating a maximum of one frangible device or having a maximum of one missing flag will maintain the MER result on Cross Country)
 - Not more than 75 seconds exceeding the optimum time in the Cross Country Test for, two, three and four star level Competitions and 100 seconds in the case of five star level Competitions.
- c) Jumping test: not more than 16 penalties at obstacles.

NOTE: All MERs obtained in previous years will be counted according to the rules in place at that time.

518 Minimum Eligibility Requirement Validity period

518.1 Championships

The valid period for obtaining a Minimum Eligibility Requirement is from the preceding calendar year to the closing date of the nominated entries.

518.2 CIs & CIOs:

The valid period for obtaining a Minimum Eligibility Requirement is anytime until:

- a) At least 24 days before the Cross Country Test of the Competition for which is needed if the MER has been achieved at a Long Format Competition (CCIs-L).
- b) At least 10 days before the Cross Country Test of the Competition for which is needed if it has been achieved at a Short Format Competition (CCIs-S).

519 Athletes Categories

FEI Athlete categories for Eventing define a recognition of proven competence of the Athlete at a certain level.

Athletes will be categorised (Uncategorised International, D, C, B, A) according to their performance in a rolling eight years period as defined in the following table.

W-CH and OG to count as 5star level MER towards Athlete categorisation.

D	Fifteen (15) MER at FEI CCI short (CCIs-S) or long (CCIs-L) format Competitions of two star level or above; or five (5) MERs at FEI CCI short (CCIs-S) or long (CCIs-L) format competitions at higher level.
C	Fifteen (15) MER at FEI CCI short (CCIs-S) or long (CCIs-L) format Competitions of three star level or above; or five (5) MERs at FEI CCI short (CCIs-S) or long (CCIs-L) format competitions at higher level.
B	Fifteen (15) MER at FEI CCI short (CCIs-S) or long (CCIs-L) format Competitions of four star level or above; or five (5) MERs at FEI long format (CCIs-L) competitions at five star level.
A	Fifteen (15) MER at FEI CCI short (CCIs-S) or long (CCIs-L) format Competitions of four star level or above of which five at five star level.

The Athlete category will be updated according to the performances on 1st of July and at the end of each calendar year taking into account the rolling eight and a half years (8.5) in order to take into consideration the cancellation of events due to the 2020 Covid pandemic.

520 Minimum Eligibility Requirements for CIs and CIOs

The following table details the requirements needed to be entered in the different formats, categories and levels of international Competitions. NFs are required to set national participation requirements as per Art 516 to apply for all categorisations.

Exceptions for MERs:

- a) The 1st activation of a frangible/deformable device (11 penalties) will still allow a MER.
- b) When multiple Minimum Eligibility Requirements are required (for CIs and CIOs), one of the Minimum Eligibility Requirements can be achieved incurring 20 penalties at the obstacles of the Cross Country Test (See below for Minimum Eligibility Requirements for Championships & Games).

~~520.1 Athletes not yet categorised at the level of the Competition~~

Athletes already categorised at the corresponding level or above, can either use the full requirements for uncategorised Athletes as a combination or the Minimum Eligibility Requirements according to their Athlete's categorisation.

~~For Athletes not yet categorised at the level of the Competition the~~ The Minimum Eligibility Requirements must be achieved as a combination according to the following table:

Unified Format:

<u>CCI1* -Intro</u>	<u>All Athletes</u>	<u>NF requirements only</u>
---------------------	---------------------	-----------------------------

Short format: incl. MER obtained as per NF Requirements

CCI2*-S	All Athletes	NF requirements only
CCI3*-S	Uncategorised Athletes	1 CCI2*-S
	D Athletes	NF requirements only
	<u>C or B or A FEI Athletes</u>	<u>NF requirements only</u>
CCI4*-S	Uncategorised or D or C Athletes	3 CCI3*-S
	<u>B or A FEI Athletes</u>	<u>1 CCI3*-S (Horse only)</u>

Long format: incl. MER obtained as per NF Requirements

CCI2*-L	All Athletes	NF requirements only
CCI3*-L	Uncategorised Athletes	2 CCI3*-S and (1 CCI2*-L or 1 CCI3*-S)
	D Athletes	1 CCI3*-S or 1 CCI2*-L
	<u>C or B or A FEI Athletes</u>	<u>1 CCI2*-L or 1 CCI3*-S (Horse only)</u>
CCI4*-L	Uncategorised or D or C Athletes	2 CCI3*-L and 1 CCI4*-S <u>or 1 CCI3*-L and 2 CCI4*-S</u>
	<u>B or A FEI Athletes</u>	<u>1 CCI3*-L (Horse only)</u>
CCI5*-L	Uncategorised or D or C Athletes	2 CCI4*-L and 3 CCI4*-S
	B Athletes	1 CCI4*-L and 3 CCI4*-S
	<u>A FEI Athletes with Horses having not obtained yet a MER at a CCI5*-L competition</u>	<u>1 CCI4*-L (as a combination)</u>
	<u>A FEI Athletes with Horses having already obtained a MER at a CCI5*-L competition</u>	<u>2 CCI4*-S (as a combination)</u>

~~**Note:** the additional qualification requirements approved by the FEI General Assembly on 23 November 2020 will come into force on 1 July 2021.~~

~~**Unified Format:**~~

CCI1*-Intro	All Athletes	NF requirements only
------------------------	-------------------------	---------------------------------

~~**520.2 Athletes already categorised at the level of the Competition**~~

~~Athletes already categorised at the corresponding level or above, can either use the full requirements for uncategorised Athletes as per Art 520.1 as a combination or the Minimum Eligibility Requirements according to the following table:-~~

~~**Short format:** incl. MER obtained as per NF Requirements~~

CCI2*-S	All Athletes	NF requirements only
CCI3*-S	C or B or A FEI Athletes	NF requirements only
CCI4*-S	B or A FEI Athletes	1 CCI3*-S (Horse only)

~~**Long format:** incl. MER obtained as per NF Requirements~~

CCI2*-L	All Athletes	NF requirements only
CCI3*-L	C or B or A FEI Athletes-	1 CCI2*-L or 1 CCI3*-S (Horse only)
CCI4*-L	B or A FEI Athletes-	1 CCI3*-L (Horse only)
CCI5*-L	A FEI Athletes with Horses having not obtained yet a MER at a CCI5*-L competition	1 CCI4*-L (as a combination)
CCI5*-L	A FEI Athletes with Horses having already obtained a MER at a CCI5*-L competition	2 CCI4*-S (as a combination)

NOTE: NFs have the option to apply to use CNs (National Competitions) for qualification purposes only to replace events cancelled due weather conditions and/or exceptional circumstances.

Targeted CNs are those for which the FEI has received and approved a request from the relevant NF for this specific purpose. MERs obtained at the specific targeted national Events will only count for upgrade in the same year and not for Athletes categorisation.

The application must be sent a minimum of 4 weeks before the Event. An FEI Level 3 Technical Delegate must function at the Event taking responsibility for the technical standards/level of the Competition and must report to the FEI (TD report) including full results.

Unified Format:

CCI1*-Intro	All Athletes	NF requirements only-
------------------------	-------------------------	----------------------------------

521 Minimum Eligibility Requirements for Championships & Games

For Championships & Games all Minimum Eligibility Requirements (MERs) must be achieved as a combination and must be clear on the obstacles of the Cross Country Test. The 1st activation of a frangible /deformable device (11 penalties) will still allow a MER.

This includes MER obtained as per NF Requirements

CH 2*	1 CCI2*-L
CH 3*	1 CCI3*-L
CH 4*	1 CCI4*-L
W-CH & Olympic Games	1 CCI5*-L or (1 CCI4*-L + 1 CCI4*-S)

For the valid period of obtaining a minimum eligibility, refer to article above: Minimum Eligibility Requirement Validity period.

Qualification for Young Horse Championships will be established separately by the Eventing Committee on an annual basis.

522 Reverse Qualification

522.1 Reverse Qualification – Horse

A reverse qualification is the obligation for a Horse to show restored competence at a lower level (MER) after a number of unsuccessful attempts at a certain level. Reverse qualification only applies to the Horse.

A reverse qualification is triggered

by two (2) consecutive Cross Country eliminations

or

a total of three (3) Cross Country eliminations within a twelve (12) months rolling period of time in international Competitions.

For this purpose the relevant reasons of elimination on Cross Country would be:

- a) Three (3) refusals
- b) Fall of Horse or Athlete
- c) Dangerous riding

Reverse qualifications remain unless cleared by a MER.

In the case of a reverse qualification at certain level the Horse must obtain a Minimum Eligibility Requirement in an international Competition at ~~a-the lower~~ level below before being allowed to compete again at the original level (e.g. Horse with 2 eliminations at 3 star level (any format) must obtain MER at 2 star level (any format) before going back to 3 star level (any format).

If a reverse qualification is triggered by eliminations that occur at different levels (any format), then the Horse must obtain a MER at the level below (any format) the highest level of Competition at which an elimination occurred.

If a reverse qualification is triggered following eliminations at 2 star level (any format) then the NF must assess the Horse at National level or at a CCI1* competition and provide a written report to the FEI Eventing Department before the Horse may again take part in any international Eventing Competition. The same principal applies to ponies reverse qualified at CCIP2 level.

522.2 Reverse Qualification - Athlete

In addition to the above, should an Athlete be fully involved with two (2) reverse qualifications within a twelve (12) months rolling period of time, their category (Art 519) will drop down one (1) level for one (1) year, as of the date of the second reverse qualification.

Chapter 6 ATHLETES AND HORSES WELFARE

523 Athletes Welfare

523.1 Medical Information

To ensure that vital information is available to first aid or medical personnel in case of emergency, athletes must comply with the following:

- a) Providing a valid contact information is mandatory for all Athletes.
The telephone number of an accompanying person/next-of-kin must be provided to the Event secretariat upon arrival (Organising Committees and medical officer to ensure all information has been received before the Cross Country).
- b) Declaration of medical condition
Athletes with medical conditions that may be relevant in the case of a medical emergency are responsible, at every Event when riding, for wearing a medical data carrier* from a system provider able to communicate information at least in English. Alternatively (and at the minimum) a medical armband of good quality can be used. Athletes who chose to wear an armband should download and fill the form available for this purpose on the FEI's website.

* *Medical data carrier (also called "medical identification tag")*: small emblem or tag worn on a bracelet, neck chain, or on the clothing, intended to alert paramedics/physicians/first responders that the wearer has an important medical condition.

Conditions that are relevant include recent head injury, serious past injuries/surgery, chronic health problems such as diabetes, long-term medications and allergies. If in doubt, the Athlete should discuss this with their own treating physician.

523.2 Medical Fitness

If there is any doubt with regard to fitness to compete of an Athlete, the Ground Jury, in consultation with the Official Medical Officer, may at its own discretion, eliminate the Athlete and decide also about their ineligibility to take part in any other Competition at that Event.

Any such elimination must be reported to the FEI through the Technical Delegate report.

523.3 Examination After a Fall

All Athletes that have had a fall during training on the Competition site or in Competition must be examined by the Official Medical Officer before they either take part in another test, Competition or leave the venue. Athletes should not re-mount their horse until the examination has been completed. The Athlete is fully responsible for ensuring that this examination takes place.

Any Athlete who leaves the venue after a fall without submitting to the examination required under this Article will automatically be issued an Eventing Recorded Warning, which will be delivered to their National Federation.

523.4 Concussion

When an Athlete has an accident that results in concussion, the Athlete must be eliminated from the Competition and is ineligible to take part in any other Competition at that Event.

524 Horses Welfare

The FEI Code of Conduct for the Welfare of the Horse should be respected at all times including and not limited to during training, preparation, travel competition, recovery and otherwise.

524.1 Veterinary Examination on Arrival

This takes place on the arrival of Horses at the Event. It is performed by the Veterinary Delegate or their deputy, who must be a qualified veterinarian. The object is to establish: first each Horse's identity, vaccination history (vaccination, etc.) other passport details and second, each Horse's state of health.

The Organising Committee must fix the place and timetable for this examination in agreement with the Veterinary Delegate and inform the Chefs d'Equipe and/or the Athletes in advance.

Doubtful cases must be reported to the Ground Jury as soon as practicable and, normally, before the first Horse Inspection.

524.2 Horse Inspections

The Horse Inspections shall be open to viewing by the public.

524.2.1 First Horse Inspection

This takes place before the Dressage Test, not more than 24 hours prior to the beginning of the Dressage test. It is conducted by the Ground Jury and the Veterinary Delegate acting together as an Inspection Panel with the President of the Ground Jury in charge.

The Horses, presented by their respective Athlete, must be inspected in hand, at rest and in movement on a firm level, clean but not slippery surface.

The Inspection Panel has the right and the duty to eliminate from the Competition any Horse that they judge is unfit, whether on account of lameness, lack of condition or for any other reason.

In the case that the fitness to compete is questionable the Ground Jury may refer the Horse to the Holding box for examination by the Holding Box Veterinarian.

Should the Athlete decide to present the Horse for Re-inspection, the Holding Box Veterinarian will report any findings to the Inspection Panel prior to the Horse being re-inspected.

Horses in the Holding Box will be under the supervision and control of a Steward and the Holding Box Veterinarian.

In the Event of equality of votes within the Inspection Panel, the President of the Ground Jury will have a second and casting vote, and the decision will be announced immediately.

524.2.2 Second Horse Inspection

This takes place before the Jumping Test. It is conducted by the same Inspection Panel and under the same conditions as the first Horse Inspection.

524.2.3 Option for Horse Inspection at Short Competitions (CCI-S)

At a short Competition the First Horse Inspection is optional, however if one is to be held the details must be published in the schedule of the Competition.

In the Event that there is no First Horse Inspection, an FEI Official Veterinarian must assess the Horse's fitness to compete including a brief trot within the Examination on Arrival pursuant to 524.1 of these Eventing rules. Horses deemed by the FEI Official Veterinarian to be unfit to compete must be reported to the Ground Jury.

In a short format competition the Second Horse Inspection will be compulsory if the Jumping Test is the last test.

524.3 Horse Welfare During the Competition

At any time during the Competition, the Ground Jury, in consultation with the Veterinary Delegate, has the right and the duty to eliminate any Horse which, in their opinion, is lame or is unfit to continue.

524.3.1 Cross Country - Warm Up

There will be a veterinarian, appointed by the Organising Committee in agreement with the Veterinary Delegate, near the start of the Cross Country to report any doubtful cases to the Ground Jury.

524.3.2 Cross Country - Finishing Area

A veterinary examination will take place after the Horse has finished the Cross Country. It is conducted by a qualified veterinarian appointed by the Organising Committee in agreement with the Veterinary Delegate.

In addition to carrying out any immediate treatment required by an injured or exhausted Horse, this veterinarian will decide if each Horse:

- a) Is fit to return immediately on foot to its own stable.
- b) Should remain for further treatment before returning to its stable.
- c) Should be transported by vehicle either direct to its stable or to a veterinary hospital.

This veterinarian has no authority to eliminate any Horse from the Competition, but must report any doubtful case of abuse of horse to the Ground Jury and to the Veterinary Delegate.

An Athlete who has retired, has been eliminated or stopped during the Cross Country Test is responsible to make sure their Horse has been checked by the Veterinary Delegate or an appointed veterinarian before leaving the venue.

Any Athlete who leaves the venue without submitting to the veterinary check required under this Article will automatically be issued an Eventing Recorded Warning, which will be delivered to their National Federation.

524.4 Appeal

At the two Horse Inspections and at any time during the Competition where a Horse may be eliminated for Horse welfare reasons, there can be no appeal against the decision of the Ground Jury.

However, if requested, the president must give a reason for the decision.

524.5 Equine Anti-doping and Controlled Medication Testing

Refer to Veterinary Regulations and EADCMRs.

525 Dangerous Riding

525.1 Definition

Any Athletes who, at any time during the Competition deliberately or unintentionally by incompetence are exposing themselves, their Horse or any third party to a higher risk than what is strictly inherent to the nature of the Competition will be considered to have acted dangerously and will be penalised accordingly to the severity of the infringement.

Such acts may include without limitation any of the following:

- a) Riding out of control (Horse clearly not responding to the Athletes restraining or driving aids).
- b) Riding fences too fast or too slow.
- c) Repeatedly standing off fences too far (pushing the Horse to the foot of the fence, firing the Horse to the fence).
- d) Repeatedly being ahead or behind the Horse movement when jumping.
- e) Series of dangerous jumps.
- f) Severe lack of responsiveness from the Horse or the Athlete.
- g) Continuing after three clear refusals, a fall, or any form of elimination.

- h) Endangering the public in any way (e.g. jumping out of the roped track).
- i) Jumping obstacles not part of the course.
- j) Wilful obstruction of an overtaking Athlete and/or not following the instructions of the Officials causing danger to another Athlete.
- k) Pressing a tired Horse

Any individual member of the Ground Jury and the Technical Delegate have the right and the duty to monitor possible cases of dangerous riding and, if appropriate and practical, to stop and eliminate an Athlete on the cross country course for dangerous riding.

If not directly witnessed by the Ground Jury, the incident must be reported as soon as possible to the Ground Jury who will decide if and how to penalise the Athlete.

The President of the Ground Jury can in addition designate one or more assistants (e.g. experienced Eventing Officials who are not in an Official function at the Competition, experienced Athletes or/and trainers not directly involved in the Competition) to help to monitor possible cases of dangerous riding in the cross country.

The President of the Ground Jury will decide their specific role, authority and reporting procedure. It is recommended that these additional Officials be grouped in pairs on the Cross Country course.

525.2 Warnings and Penalties

All cases of Dangerous Riding will incur an Eventing Recorded Warning.

In addition, depending on the circumstances of the case, either of the following measures may be imposed:

- a) 25 penalties
- b) Elimination

Note: 25 penalties are considered as an addition to scores and can be given at any time during the competition. The penalties must be reported in the results as a Cross Country obstacle penalties, Dressage penalties or Jumping obstacle penalties Any of the above sanctions applied must always be reported by the Technical Delegate to the FEI and added on the Athlete sanction list.

525.3 Elimination Before Cross Country

As a preventive risk management measure, the Ground Jury, at any time throughout the Competition, has the right and the duty to eliminate an Athlete to prevent him from starting the Cross Country Test, if there is a serious concern regarding their ability to control the Horse in that test. In addition, the Athlete must receive an Eventing Recorded Warning.

526 Abuse of Horse

526.1 Definition

Abuse of Horse means an action or omission which causes or is likely to cause pain or unnecessary discomfort to a Horse included but not limited to:

- a) Rapping.
- b) Riding an exhausted Horse.
- c) Excessive pressing of a tired Horse.
- d) Riding an obviously lame Horse.
- e) Excessive use of whip, bit and/or spurs.
- f) Horses bleeding indicating excessive use of the whip and/or spurs.

- g) Overriding: abuse of horse that does not necessarily induce visible marks
- h) Serious case of dangerous riding

If not directly witnessed by the Ground Jury, the incident must be reported as soon as possible to the Ground Jury through the Secretary of the Organising Committee or Cross Country Control Centre as appropriate. Where possible the report should be supported by a statement from one or more witnesses.

The Ground Jury must decide if there is a case to be answered.

526.2 Warnings and Penalties

Any act or series of actions that in the opinion of the Ground Jury can be considered as abuse of Horse will incur a Yellow Warning Card. In addition, depending on the circumstances of the case, one or more of the following measures may also be imposed:

- a) 25 penalties
- b) Elimination
- c) Fine
- d) Disqualification.

All cases of riding an exhausted horse will incur a Yellow Warning Card and Disqualification and the case will be referred to the FEI for further disciplinary action.

526.3 Use of the Whip

Excessive and/or misuse of the whip maybe considered abuse of Horse and will be reviewed case by case by the Ground Jury according to but not limited to the following principles:

- a) The whip is not to be used to vent an Athlete temper.
- b) The whip is not to be used after elimination.
- c) The whip is not to be used after a Horse has jumped the last fence on a course.
- d) The whip is not to be used overhand, (i.e. a whip in the right hand being used on the left flank).
- e) The whip is not to be used on a Horse head.
- f) The whip is not to be used more than two times for any one incident.
- g) Multiple excessive uses of a whip between fences.
- h) If a Horse's skin is broken or has visible marks the use of whip will always be deemed to be excessive.

526.4 Blood on Horses

Blood on Horses must be reviewed case by case by the Ground Jury. Not all cases of blood will lead to elimination an Eventing Recorded Warning or a Yellow Warning Card.

Dressage Test: If the Ground Jury suspects bleeding on the Horse during the test, the Ground Jury will stop the Horse to check. If the Horse shows fresh blood, it will be eliminated. The elimination is final. If the Judge through examination clarifies that the Horse has no fresh blood, the Horse may resume and finish its test (refer to article 430 of the FEI Dressage Rules).

Cross Country Test: For the Cross Country Test, all athlete induced (spurs, bit and whip) blood on the horse, must be reviewed case by case by the Ground Jury. If the horse shows fresh blood, Officials may authorize the rinsing or wiping of the mouth and if there is no further evidence of bleeding, the athlete is allowed to continue. Cases of significant blood will result in Elimination

Jumping Test: Horses with blood on the flank(s) and/or bleeding in the mouth will be eliminated. In minor cases of blood, such as where a Horse appears to have bitten its tongue or lip, Officials may authorize the rinsing or wiping of the mouth and allow the Athlete to continue; any further evidence of blood in the mouth will result in Elimination (refer article 241).

For all minor cases (*) of blood induced by the Athlete in the mouth or related to spurs an

Eventing Recorded Warning will be issued by the Ground Jury after providing the Athlete the opportunity to have a hearing.

(*)The cases indicating Abuse of Horse will be dealt with according to the provision of Art. 526.2 (Abuse of Horse – Warnings and Penalties).

527 Eventing Recorded Warning, Yellow Warning Cards & Suspension

The following actions will automatically result in the following sanction for the Athlete:

1. An Eventing Recorded Warning will be systematically awarded for the following offence:
 - a) Athlete continues after clear 3 refusals, a fall, or any form of elimination.
 - b) Any other case of Dangerous Riding
 - c) Athlete not seeing a Vet or a doctor after a fall
 - d) Athlete leaving the venue after having retired, been eliminated or stopped during the Cross Country Test without having their Horse checked by the Veterinary Delegate
 - e) All cases of minor Blood on Horse caused by the Athlete either in the mouth or on flanks from spurs as a minimum or by stronger sanction(s) (as provided for under Art. 526.2).
 - f) for pressing a tired horse together with 25 penalties
2. Yellow Card Warning Card will be systematically awarded for the following offence:
 - a) All cases of excessive use of whip, as defined above, or by stronger sanction(s) (as provided for under Art. 526.2).
 - b) Any other cases of Abuse of Horse
 - c) Excessive pressing of a tired horse
 - d) Riding an Exhausted horse coupled in addition to Disqualification

Before issuing an Eventing Recorded Warning or a Yellow Warning card, the Ground Jury has the duty to hear the Athlete, if available. At any time, the Athlete has the right to seek out the Ground Jury for any explanation related to an Eventing Recorded Warning or a Yellow Warning Card.

In the case of an Eventing Recorded Warning or a Yellow Warning Card being issued, after the decision of the Ground Jury, a notice stating the name of the Athlete and the reason of the warning must be posted on the Official notice board.

If after reasonable efforts the Athlete cannot be notified during the Period of the Event that the Athlete has received an Eventing Recorded Warning or a Yellow Warning Card, the Athlete must be notified in writing within fourteen (14) days of the Event.

Should the same Person Responsible receive three (3) or more Eventing Recorded Warning at the same or any other International Event within two (2) years (24 months) of the delivery of the first Eventing Recorded Warning, for any offence, the Person Responsible shall be automatically suspended for a period of two (2) months after official notification from, or on behalf of, the FEI Secretary General. The start date of the suspension shall be decided in accordance with the FEI General Regulations and confirmed in the notification.

Should the same Person Responsible receive one (1) more Yellow Warning Card at the same or any other International Event within one (1) year (12 months) of the delivery of the first Yellow Warning Card for any offence, the Person Responsible shall automatically be suspended for a period of two (2) months after official notification from or on behalf of, the FEI Secretary General. The start date of the suspension shall be decided in accordance with the FEI General Regulations and confirmed in the notification.

Chapter 7 GENERAL COMPETITION RULES

528 Classification

528.1 Individual Classification

528.1.1 Dressage Test

Each Athlete's good marks awarded by the Judges are converted into penalty points. They are recorded and published after the test for inclusion in the Dressage and final classification.

528.1.2 Cross Country Test

Each Athlete's penalties for faults at obstacles are added to the penalties for excess time and to any other penalty that the Athlete may have incurred on Cross Country. They are recorded and published after the test for inclusion in the Cross Country and final classification.

528.1.3 Jumping Test

Each Athlete's penalties for faults at obstacles are added to the penalties that the Athlete may have incurred for excess time. They are recorded and published after the test for inclusion in the Jumping and final classification.

528.1.4 Elimination

Elimination from one of the tests entails immediate elimination from the Competition.

528.1.5 Final Classification

The winner is the Athlete with the lowest total of penalty points from the three tests.

528.1.6 Final Classification Tie (Individual)

In the Event of equality between two or more Athletes, the classification is decided by:

- a) The best cross-country score including penalties for faults at obstacles, time penalties and any other penalty that the Athlete may have incurred on the Cross Country Test.
- b) If there is still equality, the classification is decided in favour of the Athlete whose cross-country time was closest to the optimum time.
- c) If there is still equality, the Athlete with the best Jumping score including penalties at obstacles and time penalties.
- d) If there is still equality, the Athlete with the fastest time in the Jumping Test.
- e) If there is still equality, the classification will be decided in favour of the Athlete with the best Overall Impression of Athlete & Horse mark in the Dressage Test.
- f) If there is still equality the tie will remain in the final classification.

528.2 Team Classification

528.2.1 Final Classification

Teams will consist of either three or four Athletes.

The winning team is the team with the lowest total of penalty points, after adding together the individual final scores of the three highest placed Athletes in the team.

For the purposes of the final team classification only, a team member who fails for any reason to complete the Competition will be awarded 1000 penalty points.

528.2.2 Final Classification Tie (Team)

In the Event of equality between any two or more teams, the classification will be decided by the best combined highest three placing.

528.3 Disqualification

Disqualification means that the Athlete, the Horse(s), and/or a combination of both is/are disqualified from the Competition at issue or from the entire Event. Disqualification may also be retroactive.

Disqualification in Eventing can apply during the Competition at the discretion of the Ground Jury:

- a) For the most serious cases of abuse of Horse.
- b) For the most serious cases of Athletes misbehaviour.

Disqualification in Eventing will apply automatically after the Competition:

- a) For having participated in a Competition without the appropriate eligibility requirements (Athlete or Horse).
- b) For having participated in a Competition without the appropriate registration (Athlete or Horse.)

528.3.1 Positive Test(s) for Substances listed on the FEI Equine Prohibited Substance list of an Athlete or Horse (refer the FEI EADCMRs and ADRHA)

529 Declaration of Starters

The declaration of starters will take place at a time to be announced by the Organising Committee. It will be after Athletes have inspected the Cross Country and after the first Horse Inspection.

If there is only an individual classification, the Organising Committee may announce that presentation at the first Horse Inspection will be assumed to be a declaration to start.

If there is a team classification, the Chefs d'Equipe must declare, in writing, the composition of the team, the starting order of the Athletes within the team and, in the case of a team with three members, which starting position shall remain vacant.

If an Athlete has presented at the first Horse Inspection more Horses than the Athlete is allowed to ride, the Athlete, or their Chef d'Equipe where applicable, must declare in writing the names of the Horse or Horses definitely starting.

If for the same level there are two or more sections the Athletes with more than one Horse have the right to have their Horses split between sections. The procedure by which Athletes are divided between sections must be specified in the Schedule.

530 Substitutions

530.1 CIs

After the closing date for entries only properly qualified Athlete/Horses, subject to the agreement of the Organising Committee, can be substituted up to one hour before the first Horse Inspection (if not applicable two hours before the start of the Dressage Test).

530.2 CIOs and Championships

After the declaration of starters, a change in the composition of a team must comply with the following:

- a) The substitution must be made at least two hours before the first Athlete is scheduled to perform their Dressage Test on the day on which the Athlete in question has been drawn to take part.
- b) In the Event of an accident or illness of an Athlete, a certificate from an officially recognised doctor must be presented.

- c) In the Event of lameness or illness of a Horse, permission from the Veterinary Delegate must be obtained.
- d) The Technical Delegate, in consultation with the Ground Jury, must approve the substitution.

531 Draw

531.1 Approval of Method of Draw

The method of draw must be approved by the Technical Delegate having consulted, if possible, with the Ground Jury. The Technical Delegate may also approve rearrangement of the order or number of blocks of teams or individual Athletes where the number of Athletes makes it necessary.

531.2 CIs

If there is only an Individual Competition, the draw will be conducted by the Organising Committee and will decide the starting order published in the programme.

531.3 CIOs and Championships

If there is a Team and an Individual Classification the draw will take place to determine the order of countries-nations for the first and second Horse Inspection. This order is also the ~~team~~ nations running order for the Dressage and Cross Country Tests.

This draw will take place prior to the first Horse Inspection, in the presence of the Ground Jury, Technical Delegate and Chefs d'Equipe. All countries-nations participating in the Competition, whether by teams or individuals, will be included in this draw.

532 Allocation of Starting Positions (CIOs and Championships)

If there is a Team and an Individual Classification the allocation of the starting positions for all Athletes in the Competition will be made after the first Horse Inspection, in the presence of the Ground Jury, Technical Delegate and Chefs d'Equipe, according to the following method.

The total starting places will be divided into eight blocks (A to H) and the Athletes will be allocated to each block as follows:

- a) Block A - first Athlete in each team
- b) Block B - twenty five percent (25) of individual Athletes
- c) Block C - second Athlete in each team
- d) Block D - twenty five percent (25) of individual Athletes
- e) Block E - twenty five percent (25) of individual Athletes
- f) Block F - third Athlete in each team
- g) Block G - twenty five percent (25) of individual Athletes
- h) Block H - fourth Athlete in each team

532.1 Team Members Positions

The team members positions will be filled first according to the draw of countries (art. 531.3) and the starting order within each team previously declared, after the Horse Inspection, by its Chef d'Equipe. The Chef d'Equipe of a team with only three members must declare which starting position shall remain vacant.

532.2 Individuals Positions

The individuals positions will then be determined as follows:

- a) Athletes with one Horse in the Team Competition, second Horses will be placed by the Chefs d'Equipe in any of the remaining unallocated starting places of Block G, free choice in sequence according to the draw of countries (art. 531.3).
- b) Athletes with two Horses in the Individual Competition will be placed by Chefs d'Equipe in any of the remaining unallocated starting places of Block B and G, free choice in sequence according to the draw of countries (art. 531.3). Only one such Athlete's Horses may be placed by a Chef d'Equipe until their turn in the sequence recurs.
- c) Athletes with one Horse in the Individual Competition without a representative team will be placed by the Chefs d'Equipe in any of the remaining unallocated starting places of blocks B, D, E, or G, free choice in sequence according to the draw of countries (art. 531.3).
- d) Athletes with one Horse in the Individual Competition with a representative team will be placed by the Chefs d'Equipe in any of the remaining unallocated starting places of blocks B, D, E, or G, free choice in sequence according to the draw of countries (art. 531.3).

More than one member of a team will be permitted to ride two Horses only if there are enough Athletes in the Event to allow both Horses to be fitted into the time schedule in accordance with the above paragraph.

533 Starting Order

533.1 CCI-L and CCI-S with order of tests Dressage-Cross Country – Jumping Long Competitions

533.1.1 Dressage and Cross Country Tests

The drawn starting order will be used for both these tests.

533.1.2 Jumping Test

The starting order must follow the reverse order of classification at the end of the Cross Country Test (i.e. the lowest placed Athlete will start first, and the last Athlete to jump will be the one placed highest).

533.2 CCI-S with order of tests Dressage-Jumping-Cross Country Short Competitions

533.2.1 Dressage and Jumping Tests

The drawn starting order will used for both these tests.

533.2.2 Cross Country Test

At the discretion of the Organising Committee:

- a) May follow the same draw starting order of the Dressage and Jumping Tests.
- b) May be run in reverse order of classification for the best 25 percent of competitors. The same draw starting order of the Dressage and Jumping Tests will be followed for the remaining competitors.

~~If two Horses ridden by the same Athlete are classified too close to each other, the starting order of the lower placed one must be adjusted.—~~

533.2.3 Athletes with multiple rides

An athlete with multiple rides cannot change the relative order of their horses. However, if required by the timetable and agreed by the Ground Jury and the Technical Delegate, the Athlete may start one or more horses at other than the normally scheduled starting time for both Jumping and Cross Country tests.

If an athlete is starting multiple horses in different classes, if possible the starting time of the lower class should be adjusted.

534 Timetable

534.1 Dressage Test

A timetable showing each Athlete's starting time for the Dressage Test will be available to each Athlete. The interval between starting times will be at the discretion of the Organising Committee, with the approval of the Technical Delegate.

534.2 Cross-Country Test

A timetable, showing each Athlete's starting time must be available to each Athlete no later than one hour after the end of the Dressage Test.

The interval between starting times will be at the discretion of the Organising Committee, with the approval of the Technical Delegate.

534.3 Jumping Test

A time schedule showing the start and the approximate finish of the Jumping Test shall be published. If the time schedule is split, for example between morning and afternoon sessions, the number of Athletes that will jump in the second session shall be noted.

534.4 Minimum Interval Between Tests

If the Cross Country Test takes place before the Jumping Test, the minimum interval between Tests must be 60 minutes.

535 Exercising and Warming Up

535.1 Identification Number

Upon arrival, each Horse is issued with an identification number, which must be worn at all times. It may be replaced by the draw number, which must then be worn until the end of the Competition.

Failure to display either number incurs first a warning and, in the case of a repeated offence, a fine imposed on the Athlete by the Ground Jury.

535.2 Restrictions on Schooling Horses

535.2.1 Period of Restriction

During the three days before the start of the first Horse Inspection or the Dressage Test, as applicable, and for the entire duration of the Competition it is forbidden, under penalty of elimination, for anyone to school a Horse other than the Athlete who will ride the Horse in the Competition.

535.2.2 Hacking and Exercising

A groom, while mounted, is not permitted to school the Horse but only to hack it, or ride it on long reins. A groom may also work the Horse on the lunge.

535.2.3 Forbidden Areas

Under penalty of elimination, riding close to Cross Country obstacles, or riding in the dressage or jumping arenas prior to the actual Competition is forbidden, unless specifically authorised by the Ground Jury or the Technical Delegate.

535.3 Exercise Areas

Appropriate areas suitable for the general exercise of Horses must be made available by the Organising Committee and must be open throughout the hours of daylight.

The Organising Committee must inform Athletes of the areas that are available for this purpose. Horses may be exercised only in such designated areas and/or in the practice and warm areas up for Dressage, Cross Country and Jumping.

535.4 Practice Areas

535.4.1 Practice Dressage Areas

At least one dressage practice arena of 60 by 20 meters must be put at the disposal of the Athletes two days before the first day of the Dressage Test. If possible, this arena should be of the same footing as the Competition arena.

535.4.2 Practice Jumping Areas

The Organising Committee must provide one or more practice areas with both fixed and knock down obstacles. The following will apply:

- a) The only practice obstacles that Athletes may jump are those provided by the Organising Committee.
- b) All obstacles must be marked with red and white flags.
- c) The practice obstacles shall only be jumped at times laid down by the Organising Committee.
- d) The Organising Committee must provide at least two fixed cross country practice obstacles
- e) The dimensions of any fixed practice obstacle, either in the practice or warm up areas, may never exceed those of the relevant Cross Country Test.
- f) The knock down obstacles, either in Cross Country or Jumping practice / warm up areas may never be raised more than 10 centimetres above the maximum height permitted by the relevant Test and the spread may never exceed the maximum permitted by the relevant Test.
- g) No part of a knock down obstacle may ever be held by anyone.

535.5 Warm Up Areas

Warm up areas must be provided by the Organising Committee in the vicinity of the relevant Competition arenas for the Dressage and Jumping Tests and close to the start for the Cross Country Test.

Warm up areas may be the same of the practice areas if the dimensions, layout and quality of the footing can allow for it with the following minimum requirements.

535.5.1 Dressage

At least one practice arena of 60 by 20 meters must be put at the disposal of the Athlete next to compete.

535.5.2 Cross Country

At least two fixed or knock down obstacles marked with red and white flags.

535.5.3 Jumping

At least two knock down obstacles marked with red and white flags.

535.6 Dressage Familiarization

535.6.1 Dressage familiarization

In order to familiarize the Horse with the Competition arena prior to the Dressage Test, Athletes and Grooms may, if conditions and the timetable allow, be permitted at a time agreed by the

Organising Committee to walk and lead the Horse on a long rein outside the boards of the Competition arena.

In the case of all-weather surfaces the Organising Committee may, if timetable allows, permit schooling inside (with Athletes only) and/or outside the boards.

535.7 Stewarding

One or more Stewards must be appointed to ensure that the rules regarding exercising and warming up are obeyed.

The jumping obstacles can only be used if supervised by a Steward.

Other practice and exercise areas may be patrolled by Stewards in a random manner. Violation of any of the provisions relating to practice obstacles is forbidden under penalty of elimination.

536 Access to Courses and Arenas

536.1 Dressage Arena

Unless permission is given by the Ground Jury, it is forbidden for Athletes, under penalty of elimination, to enter the arena mounted at any time other than when performing their test during the Competition. The arena may be inspected on foot prior to the start or during breaks in the Competition.

536.1.1

In Eventing, it is not compulsory to close the Dressage arena.

536.2 Cross Country Course

It is forbidden, under penalty of elimination, to the Athletes to inspect the obstacles or the course before it is officially open.

536.2.1 Opening Time

The Cross Country Course will be opened to all Athletes at the latest the day before the Cross Country Test. After the course has been officially opened Athletes are allowed to revisit the course and examine the obstacles during the hours of daylight. This examination must take place on foot only unless special permission is given by the Ground Jury.

536.2.2 Flags and Markers

All obstacles, flags and markers must be exactly in position when the course is opened to Athletes. They may not be moved or altered by Athletes under penalty of elimination.

536.3 Jumping Course

The course for the Jumping Test will be open to Athletes not less than 15 minutes before the start of the Jumping Test. Permission to enter the arena will be given by the Ground Jury and an announcement must be made over the public address system.

Athletes will be only admitted to inspect the course on foot between the opening of the course and the start of the Jumping Test.

Unless special permission is given by the Ground Jury, it is forbidden for Athletes, under penalty of elimination, to enter the arena on foot once the Jumping Test has started.

537 Interruptions and Modifications

537.1 Interruptions

The timetable may be interrupted due to dangerous conditions. If necessary, the start of any

test or phase may be interrupted, postponed or cancelled.

The decision to interrupt, postpone or cancel a test will be made by the President of the Ground Jury, if possible, after consultation with the other members of the Ground Jury and the Technical Delegate.

In the case of an interruption, the Competition will be resumed as soon as possible at the point of the interruption. Every affected Athlete must receive sufficient warning before the resumption of the Competition.

537.2 Modifications

After the courses have been officially shown to the Athletes, alterations may be made only in exceptional circumstances and/or when specifically requested by the Athlete representative or Chef d'Equipes and agreed by the Ground Jury in consultation with the Technical Delegate and Course Designer.

Any such modification must be notified to the Athletes at the Cross Country briefing.

After the Cross Country Test has started alterations may be made only when exceptional circumstances (such as heavy rain or hot weather) make obstacles or a test unfair or dangerous.

The decision will be taken by the President of the Ground Jury after consultation, if possible, with the other members of the Ground Jury and Technical Delegate.

In such cases, the Chefs d'Equipe and every Athlete must be officially and personally informed of the alteration before the start of the phase or the test concerned. Where appropriate, an Official must also be stationed at the place where the alteration has been made in order to warn the Athletes.

538 Dress

538.1 General

Whist riding in Competition, Athletes must ensure that long hair is tied and neat.

538.1.1 Protective Headgear *

While riding anywhere on the show grounds, the use of a properly fastened Protective Headgear is mandatory. ~~Such~~ Protective headgear must comply with [the list of the applicable international testing standards published on the FEI website](#). ~~any of the European (EN), British (PAS), North American (ASTM), Australian/New Zealand tested standards applicable at the time of the competition.~~

Failure to wear such Protective Headgear where and when required after being notified to do so by an Official, shall result in a Yellow Warning Card, being issued to the Athlete unless exceptional circumstances apply.

As an exception, Senior Athletes may be allowed to remove their Headgear while accepting prizes or during the national anthem. It is recommended that Athletes not remove their Headgear during the lap of honour.

538.1.2 Whips

- a) Training - A whip no longer than one 120 centimetres including lash is allowed when riding on the flat at any time. A whip no longer than 75 centimetres and not weighted at the end is allowed while jumping any obstacle.
- b) Horse Inspections - A whip no longer than 120 centimetres including lash is allowed at the Horse Inspections.
- c) Dressage Test - A whip is not allowed entering the space around the arena and during the Test
- d) Cross Country and Jumping Tests - A whip no longer than 75 centimetres and not weighted at the end is allowed during these tests.

538.1.3 Spurs

- a) General - Spurs are optional for all three Tests. Spurs capable of wounding a Horse are forbidden. Spurs must be of smooth material (metal or plastic). If there is a shank it must not be more than four centimetres long (the overall shank must be measured from the boot to the end of the spur) and must point only towards the rear. The end of the shank must be blunt to prevent wounding a Horse. If the shank is curved, the spurs must be worn only with the shank directed downwards. Metal or plastic spurs with round hard plastic or metal knobs "Impulse spurs" and "Dummy spurs" with no shank are allowed.
- b) Rowel Spurs - Spurs with rowels are allowed in the three Tests and when practising/warming up. If they are used, rowels must be free to rotate and the rowel must be round and smooth (no tines allowed). For pony competition, rowel spurs are not allowed for all tests.

538.1.4 Boots

Boots worn during the Dressage and Jumping Tests (other than as part of regulation service dress) must be black, brown or black with a brown top.

538.2 Dressage Test

538.2.1 Civilian

Hunting dress or uniform of a riding club; a tail coat or jacket approved by the Athlete's NF (contrast colouring and piping is allowed); white shirt and tie; gloves; white, fawn or cream breeches; long riding boots (or short boots with matching full grain smooth leather chaps); protective headgear.

At lower level events, civilian may also wear a tweed jacket with fawn or beige breeches and black or brown boots.

Please refer to Dressage Rules in regard to use of protective headgear, as well as entering the arena with whip, with boots on Horse's leg or with discrepancy in dress.

538.2.2 Members and employees of military establishments and national studs

Service dress and gloves, protective headgear are compulsory for members and employees of military establishments and national studs.

538.3 Cross-Country Test

Body protectors* are compulsory for this Test, including when schooling over Cross-Country fences, at any time.

[The use of air vests is recommended.](#)

[*Back Protectors are not considered body protectors.](#)

538.4 Jumping Test

538.4.1 Civilian

Hunting dress or uniform of a riding club; a uniform or jacket approved by the Athlete's NF (contrast colouring and piping is allowed); white shirt and tie; white, fawn or cream breeches; boots are compulsory for this Test. At lower level events, civilian may also wear a tweed jacket with fawn or beige breeches and black or brown boots.

538.4.2 Members of Armed and Police Forces

Service dress are compulsory for members and employees of military establishments and national studs.

538.5 Inspection of Dress

A Steward can be appointed to inspect whips, spurs and item of dress before any Test.

The Steward has the authority to refuse permission to start for any Athlete, whose whip or spurs or safety equipment contravene articles 538. The Steward will immediately report the circumstances to the Ground Jury for confirmation.

An Athlete who competes with illegal whip(s), spurs or incorrect items of dress is liable to elimination, at the discretion of the Ground Jury.

539 Saddlery / Dress

Please also refer to FAQ guidelines on Tack, Equipment and Dress for latest clarifications, published on the FEI website. See also Art. 538.2.1.

539.1 Training and Exercising

539.1.1 Compulsory

An English type saddle and any form of bridle, including double bridle, snaffle, gag or hackamores are compulsory.

539.1.2 Permitted

Running martingales, Irish martingales, bit guards, boots, bandages, fly shields, nose covers and saddle covers are permitted.

Leather, sheepskin or similar material may be used on each cheek piece of the bridle providing the material does not exceed three centimeters in diameter measured from the Horse's cheek.

539.1.3 Permitted for Lunging

Single direct side reins are permitted only while lunging (only with one lunge line) as are running reins and chambons.

539.1.4 Forbidden

Other martingales, any other kind of gadget (such as bearing, side or balancing reins, etc.) and any form of blinkers, are forbidden under penalty of elimination.

539.2 Dressage Test

539.2.1 Compulsory

An English type saddle and a permitted bridle are compulsory.

539.2.2 Permitted

- a) A double bridle with cavesson noseband i.e. bridoon and curb with curb chain (made of metal or leather or a combination), (Cover for curb "chain" can be made of leather, rubber or sheep skin) is permitted, as authorized in Annex A. Use of double bridles during Dressage test allowed for 4* and 5* competitions only. Bridoon and curb must be made of metal and/or rigid plastic and may be covered with rubber/latex. The lever arm of the curb bit is limited to ten centimetres (10 cm) (length below the mouth piece). The upper cheek must not be longer than the lower cheek. If the curb has a sliding mouthpiece, the lever arm of the curb bit below the mouth piece should not measure more than ten centimetres (10 cm) when the mouth piece is at the uppermost position. Curb "chain" can be made of metal or leather or a combination. Cover for curb "chain" can be made of leather, rubber or sheep skin. The diameter of the mouthpiece of the bridoon and/or curb must be such so as not to hurt the Horse. Minimum diameter of mouthpiece to be twelve millimetres (12 mm) for curb bit and ten millimetres (10 mm) for bridoon bit.
- b) A snaffle bridle of which the bit is made of metal, flexible rubber or synthetic, or plastic or leather material is also permitted as authorised in Annex A. Snaffles are permitted and

must have a minimum diameter of fourteen millimetres (14 mm). For Ponies the minimum diameter shall be ten millimetres (10 mm). The diameter of the mouthpiece is measured adjacent to the rings or the cheeks of the mouthpiece. The reins must be attached to the bit.

- c) The bridle must be made entirely of leather or leather-like material, except for a small disc of soft padding, which may be used under the intersection of the two leather straps of a crossed noseband, on the poll or underneath the noseband.
- e)d) A browband is required and except for the parts that attach to the crownpiece or headstall, is not required to be made of leather or leather-like material
- d)e) A breast plate may be used.
- e)f) Ear hoods are permitted for all Events and may also provide noise reduction. However, ear hoods must allow for ears to move freely and must not cover the Horse's eyes and ear plugs are not permitted (with the exception of prize giving ceremonies). The ear hoods should be discreet in colour and design. Ear hoods may not be attached to the noseband.

Note: For sponsor logo and national identification on Ear hoods - see General Regulations art. 135.

For drawings of permitted bits and nosebands, see Annex A – Saddlery, table Bits and table Nosebands. Certain tests may specify that only a snaffle bridle is allowed.

539.2.3 Forbidden

Martingales, bit guards, any kind of gadgets (such as bearing, side, running or balancing reins, etc.), any form of blinkers, earplugs, nose covers and saddle covers, are under penalty of elimination, strictly forbidden.

False tails are permitted provided they are not weighted or otherwise enhanced in any way whatsoever.

Bits where the mouthpieces rings restrict the reins to move freely are not permitted as well as bits that can slide vertically creating a gag effect.

Any pieces of tack that impairs the ears to move freely is forbidden.

539.3 Cross Country and Jumping Tests

539.3.1 Permitted

The type of saddlery is optional. Gags are allowed as are unrestricted running martingales or Irish martingales. Reins must be attached to the bit(s) or directly to the bridle. The stirrup iron and stirrup leathers must hang free from the bar of the saddle and outside of the flap.

539.3.2 Forbidden

Any form of blinkers, side, running or balancing reins; tongue straps and/or tying down the Horse's tongue; any other restrictions, any bit or other item of saddlery likely to wound a Horse are forbidden.

Any pieces of tack that impairs the ears to move freely is forbidden.

For Cross Country, any addition to the cheekpiece is forbidden (sheepskin or additional material).

For Jumping only, leather, sheepskin or similar material may be used on each cheek piece of the bridle providing the material does not exceed three centimeters in diameter measured from the Horse's cheek.

Any device which does not allow an immediate and unrestricted separation of the Athlete's boot from the stirrup in case of a fall is forbidden. Any gadget which does not allow an immediate and unrestricted separation of the Athlete in case of a fall, is forbidden.

Neck straps, if used on Cross Country, must be attached either to the breastplate or to the saddle.

For Cross Country, a throat lash is compulsory to maintain the bridle in place

For Cross Country, bitless bridles are not allowed.

For Cross Country, hackamores must be used with a bit. without bits are not allowed. The maximum length of the shank is 24 cm, measured in a straight line from the middle of the higher ring to the middle of the lower ring.

~~For Cross Country, bits with a lever arm. The lower cheek (lever arm) on any bit may not exceed 10 cm. The length of the lever arm is measured in a straight line from the highest point where the bit is stopped to the lowest point of the lever arm.~~

~~For Cross Country, bitless bridles are not allowed.~~

539.3.3 Jumping Test - Boots

For the Jumping Test, the total maximum weight of equipment allowed to be added to a Horse's leg, front or hind (single or multiple boots, fetlock rings etc), is five hundred (500) grams (shoe excluded).

The use of hind boots for the Jumping test must comply with art. 257 of the Jumping rules.

Failure to comply with this paragraph will incur elimination.

539.4 Inspection of Saddlery

A Steward can be appointed to check the saddlery of each Horse before it enters the arena or starts a test.

In the Dressage Test the checking of the bridle must be done with the greatest caution.

If the Athlete so requests, the bridle and bit may be checked immediately after the test has been completed. However, should the bridle or bit in such a case be found not to be permitted, the Athlete will be eliminated.

540 Unauthorised Assistance

Any intervention by a third party, whether solicited or not, with the object of facilitating the task of the Athlete or of helping their Horse, is considered unauthorised assistance and the Athlete is liable to be eliminated at the discretion of the Ground Jury.

Officials or spectators who draw the attention of an Athlete to a deviation from the course will be considered giving unauthorised assistance which may result in the elimination of the Athlete.

In particular in the Cross Country Test the following will be considered unauthorised assistance:

- a) To take intentionally a lead from another Athlete.
- b) To be followed, preceded or accompanied, on any part of the course, by any vehicle, bicycle, pedestrian, or Horseman not in the Competition.
- c) To post friends at certain points to call directions or make signals in passing.
- d) To have someone at an obstacle to encourage the Horse by any means whatsoever.
- e) To tamper with the obstacles or any part of the course, including, for instance, flags, indicators, markers, notices, ropes, trees, branches, wire or fences, whether temporary or permanent.

540.1 Exceptions

- a) Whip, headgear or spectacles may be handed to an Athlete without dismounting during the Cross Country Test.
- b) An Athlete, after having knocked a flag at an obstacle as a consequence of a run-out, may ask the fence Judge for the flag to be repositioned, but no time will be deducted.

540.2 Receiving Apparatus / Cameras

The use of any receiving apparatus by Athletes is strictly forbidden while mounted during the test.

Automatic recording of data during the test (e.g. heart beat monitoring, temperature, etc.) to be used for research purposes after the completion of the test is allowed.

For use of cameras on athletes or equipment – see General Regulations. For FEI Named-Events request for use of cameras must be approved by FEI HQ, request for approval for other events must be reviewed by the Technical Delegate in consultation with the Organiser.

541 Advertising and Publicity on Athletes and Horses

Subject to the provisions of article 135 General Regulations, the manufacturer logo can appear, specifically for Eventing: at all Events, except Regional and Olympic Games under the patronage of the IOC, Athletes may wear clothing and use equipment (including, but not limited to, riding equipment) which identify the manufacturer, the Athletes' sponsor(s), the Athletes' team sponsor(s), the National Federation's sponsor(s), the Athletes' nation, and/or the Athletes themselves, but only under the specific conditions set forth below.

541.1 Identification of a Non-Sponsor Manufacturer

While present in the Competition area and during the prize-giving ceremonies names or logos identifying a non-sponsoring manufacturer of the clothing, and equipment may appear only once per item of clothing, and/or equipment and solely on a surface area not exceeding: - three square centimetres (3 cm²) for clothing and equipment

541.2 Identification of a Sponsor

While present in the Competition area and during the prize-giving ceremonies the name and/or logo of the Athletes' sponsor(s), their team sponsor(s) and/or their National Federation's sponsor(s) may appear on a surface area not exceeding:

- a) Two hundred square centimetres (200 cm²) on each side of saddle cloth;
- b) Eighty square centimetres (80 cm²) on each of the two sides of jackets or top garment at the height of breast pockets for Jumping Events, Dressage Events and for Jumping and Dressage Tests of Eventing;
- c) Eighty square centimetres (80 cm²) only once lengthwise on the left leg of the riding breeches during the Dressage, Cross-Country and Jumping tests of Eventing. In any case, the surface area on the riding breeches should be dedicated to the visibility of the following only: the Athlete's name, identification of the Athlete's nationality, the name and/or logo of the Athlete's sponsor(s), their team sponsor(s) and/or their National Federation's sponsor(s);
- d) Sixteen square centimetres (16 cm²) on both sides of the shirt collar;
- e) Either two hundred square centimetres (200 cm²) on one arm of jackets or top garment or one hundred square centimetres (100 cm²) on each arm of jackets or top garment for the Cross-Country tests of Eventing
- f) One hundred twenty five square centimetres (125 cm²) vertically in the middle of the hard hat for the Jumping and Cross-Country tests of Eventing;
- g) Seventy five square centimetres (75 cm²) for the logo on ear hoods in Dressage, Jumping and Cross Country Tests of Eventing.

541.3 Use at FEI Championships

Notwithstanding the above, Organising Committees of FEI Championships may prohibit such names and logos in the schedule, with the exception of the names and logos of the team sponsors and/or of the National Federation sponsor(s) under the limitations as set forth in Article

135.2.2.1 of the General Regulations.

541.4 Organising Committee Sponsor

The Organising Committee may display the name and/or logo of a Competition and/or Event sponsor(s) on members of the Organising Committee crew present in the Competition area and on numbers present on front and back of the bibs worn by Athletes during the Cross-Country tests of Eventing, as well as on stable rugs when they are in the Competition area and during the prize-giving ceremonies at all FEI Events. The size of name and/or logo on Athlete's number shall not exceed 100 cm².

541.5 Athlete's National Identification

While present in the Competition area and during the prize-giving ceremonies the name or logo of the Athlete's nation, its national symbol and/or its national flag, and/or the Athlete's National Federation logo or name may appear on a surface area not exceeding:

- a) A reasonable size on each of the two (2) sides of jackets or top garment, at the height of breast pockets and on the collar for Jumping and Dressage Tests of Eventing.
- b) Two hundred square centimetres (200 cm²) on each side of saddle cloth.
- c) Either two hundred square centimetres (200 cm²) on one arm of jackets or top garment or one hundred square centimetres (100 cm²) on each arm of jackets or top garment for the Cross-Country tests of Eventing
 - Vertically in the middle part of the hard hat for the Jumping Events;
 - Vertically in the middle part of the protective head gear of Dressage;
 - Vertically in the middle part of the protective head gear of Eventing National colors may appear on the entire surface of such protective headgear.
- d) Seventy five square centimetres (75cm²) for the logo on ear hood in Dressage, Jumping and Cross Country Tests of Eventing.

In any case, the Athlete's national identification can be combined in the same surface area with the name and/or logo of the Athlete's sponsor(s), their team sponsor(s) and/or the National Federation's sponsor(s) as long as their presence and visibility are in compliance with the surface areas mentioned in art.135 2.2.1 and 2.3.1 of the General Regulations.

For Championship and Official team competitions Cross Country test, members of the national teams are required to use national identification colours for equipment, dress and saddle pads to clearly identify and differentiate visually the competing countries. Colours and pattern are to be registered in advance with the FEI.

The Athlete's national flag or the Official three letter IOC abbreviation for the nation may appear on the back of the Athlete's jacket for Jumping centred between the shoulders. The top of the flag, or the three letter abbreviation (as applicable) must be placed 4cm below the collar. The flag may not be more than 25cm wide, with a height in proportion to the width; the three letter IOC abbreviation must appear in standard IOC typeface and not exceed a height of 8 cm."

All Athletes and horses should wear a minimum of one item with national identification per Athlete and Horse

541.6 Athlete's Name

While present in the Competition area and during the prize-giving ceremonies the Athlete's name may appear on a surface area not exceeding:

- e) Eighty square centimetres (80 cm²) only once lengthwise on the left leg of the riding breeches during the Jumping and Cross Country Tests of Eventing.

541.7 National Federation Logo

Unless otherwise specified in this Article, no advertisement or publicity is permitted on any Athlete, Official, Horse, or riding equipment while present in any Competition area or during the

performance. However, Athletes inspecting the course may wear the logo of their sponsor, their team sponsor(s), and/or of their National Federation's sponsor(s) and/or their nationality within a frame not exceeding four hundred square centimetres (400 cm²) on the front and back of their top garments and within a frame not exceeding fifty square centimetres (50 cm²) on head gear.

541.8 Advertising in Field of Play

Unless otherwise provided in the Sport Rules, advertising may appear on obstacles, fences and on the sides of the arena provided any applicable broadcast, internet, or similar law or agreement permits such advertising.

541.9 Definition of competition area

Unless otherwise agreed in writing by the FEI, for the purpose of this Article, the Competition area shall include all areas where the Athlete is being judged or their Horse is undergoing a Horse inspection. It shall not include collecting rings and start and finish box.

541.10 (as per General Regulations 135.8)

The Chief Steward is responsible for ensuring that the above provisions are respected by Athletes before entering the arena. Athletes not complying with the above will not be permitted to enter the arena during competition. An official clothing approved by a NF not complying with the requirements of this Article will not be authorised by the FEI.

Chapter 8 DRESSAGE TEST

542 FEI Dressage Rules

The FEI Dressage Rules apply for the Eventing Dressage Test except where otherwise provided in these Eventing Rules. Any modification introduced to the FEI Dressage Rules during the year will be evaluated for inclusion in these Eventing Rules from 1st January the following year.

543 Administration

543.1 Type and level of Test

The type and level of the test will be determined by the type and level of the Competition and will, therefore, be related to the quality and the standard of preparation of the Athletes and Horses.

543.1.1 CIs and CIOs

Organising Committees are free to select the specific test to be used within the one shown in Dressage Annex table Dressage Tests according to the level of the Competitions.

543.1.2 Championships and Games

For all Championships and Games the "B" test will be used unless specified differently by the FEI.

543.2 Number of Tests to be judged by day

The Organising Committee may include a maximum of fifty (50) Horses per day to be judged by one Ground Jury, with an additional flexibility of maximum ten (10) percent, if agreed by the Technical Delegate and the President of the Ground Jury.

543.3 Judges Positions

Two of the three Judges must be placed along the short side, on the outside of and five metres from the arena. The president (C) shall be on the prolongation of the centre line, the other (M or H) two point fifty metres from and on the inside of the prolongation of the long sides.

The third Judge will be at either E or B, outside and five to ten metres from the arena. The three positions shall be either C, H, B or C, M, E, as determined by the Technical Delegate, taking into account the test and the position of the sun.

In the case of only two Judges they will be positioned at C and either B or E, as determined by the Technical Delegate, taking into account the test and the position of the sun.

A separate hut must be provided for each Judge. They must be raised not less than fifty (50) centimetres above the ground, in order to give the Judges a good view of the arena.

544 Scoring

544.1 Marking

544.1.1 Good Marks

Judges will award good marks from zero to ten (10) including half marks for each numbered movement and for ~~each of the~~ collective-harmony marks.

544.1.2 Scoring Flying Change

For 4* Championships and higher level Events, if the score for a flying change varies by 3 points or more between the Judges, the Ground Jury will review the official video as soon as possible

after the Dressage test. The review must be on the same day.

Corrections may only be made to the flying change score with the agreement of the Ground Jury and should be based on one or more of the original score(s)

544.1.3 Paperless Judging

Organiser have the option to use Paperless judging systems.

If used, any paperless judging system is subject to FEI approval and must be stated in the Event schedule.

FEI approved paperless judging systems as per the FEI requirements are posted on the FEI Website.

In any event, a paper version of the Dressage tests must be available to the Judges during competition as backup.

544.2 Calculation of Scores

544.2.1 Good Marks & Errors

The good marks from zero to ten (10) awarded by each Judge to an Athlete for each numbered movement of the Dressage Test together with the **collective-harmony** marks are added together deducting any error of course or test.

544.2.2 Judges Percentages

For each Judge the percentage of maximum possible good marks obtainable is then calculated. Percentage is obtained dividing total good marks and errors of the Judge by maximum possible good marks obtainable and then multiplying by 100 and rounding the result to two decimal digits. This value is shown as the individual mark for that Judge.

Rounding the result to two decimals includes any score of "x.xx5" and above is round up and any score less than "x.xx5" in rounded down.

544.2.3 Athletes Percentage

Athlete's percentage is calculated on the average good marks and errors obtained by adding together the total good marks for each Judge and dividing by the number of Judges. The Athletes percentage will always be rounded to two decimal digits.

544.2.4 Penalty Points

In order to convert Athletes percentage into penalty points, this must be subtracted from 100 with the resulting figure being rounded to one decimal digit. The result is the score in penalty points for the test.

Rounding the result to one decimal includes any score of "x.x5" and above is round up and any score less than "x.x5" is rounded down

Eventing Dressage test error penalties:

1st time	Two (2) points
2nd time	Four (4) points
3rd time	Elimination
Other errors:	Two (2) points per error to be deducted

Note: The Eventing Rules will not line up with the Dressage modifications, and maintains the 2015 ruling on error penalties for the Eventing Dressage Test.

544.2.5 Overall Impression of Athlete and Horse Mark

In all Eventing Dressage Tests, one overall mark will be awarded for the Harmony of Athlete and Horse with a double coefficient.

Chapter 9 CROSS COUNTRY TEST

545 Rules Governing the Cross Country Test

545.1 Starting

545.1.1 Starting Procedure

Athletes at the start of the Cross Country must be under the control of the starter and may not deliberately start until instructed to do so, under penalty of elimination at the discretion of the Ground Jury.

The Horse does not have to stand absolutely immobile, but the Athlete must not get any advantage from a flying start.

Each Athlete should be given reasonable warning before the time the Athlete is due to start, but it is the Athlete's responsibility to ensure that the Athlete is ready to start at the correct time.

545.1.2 Starting Box

In order to simplify the task of the starter, an enclosure approximately five meters per five meters will be built at the start of the Cross Country, with an open front through which Horses will start and a gap in one or both sides from which the Horses will enter.

Each Athlete must start from within the enclosure and is at liberty to move around and through the enclosure as the Athlete pleases.

An attendant may lead the Horse into the enclosure and may hold the Horse until the signal to start is given. From that instant, the Athlete is considered to be on the course and no further assistance may be given.

545.2 Optimum Time and Timing

545.2.1 Optimum Time / Time Limit

The distance chosen, carried out at the chosen speed, gives the optimum time. Completing in less than the optimum time is not rewarded. An Athlete exceeding the optimum time will be penalised in accordance with art. 548.2 up to the time limit.

The time limit is twice the optimum time.

545.2.2 Timing

Each Athlete will be timed on the Cross Country Test from the moment the signal to start is given or from the moment the Athlete crosses the starting line which ever happens first to the moment the Athletes crosses the finishing line.

If an Athlete is stopped by an Official, e.g. for a broken fence, accident, being overtaken, for medical or veterinary examination, etc., the time during which the Athlete is prevented from continuing until the Athlete is cleared to start will be recorded and deducted from the total time taken to complete the Cross Country Test.

545.3 Error of Course

All compulsory passages on Cross Country and all obstacles, including all elements and/or options, must be passed or jumped in order under penalty of elimination.

All red or white flags must be respected wherever they occur on course under penalty of elimination except as provided in art. 549.2 & 549.4.

Retaking an obstacle already jumped is forbidden, under penalty of elimination, except as provided for in art. 549.2 & 549.4.

545.4 Pace and Dismounting

Between the start and finish of the Cross Country Test, Athletes are free to choose their own pace.

Athletes may voluntarily dismount without incurring elimination according to art. 549.5.1 to check on Horse, adjust saddlery or equipment, or when held on course.

545.5 Overtaking

Any Athlete who is about to be overtaken by a following Athlete must quickly clear the way.

Any Athlete overtaking another Athlete must do so only at a safe and suitable place.

When the leading Athlete is before an obstacle and about to be overtaken, the Athlete must follow the directions of the Officials.

When the leading Athlete is committed to jump an obstacle, the following Athlete may jump that obstacle only in such a way that will cause no inconvenience or danger for either.

545.6 Athlete in Difficulty

If, in attempting to negotiate an obstacle, a Horse should be trapped in such a way that it is unable to proceed without assistance or is liable to injure itself, the Athlete will be instructed by the fence Judge to dismount and will be eliminated.

The fence Judge will decide if parts of the obstacle need to be dismantled or if any other assistance needs to be given to extricate the Horse.

545.7 Stopping Athletes

If any part of an obstacle is obstructed by an Athlete in difficulty, or if any obstacle has been dismantled to release a fallen Horse, or if an obstacle has been broken and is not yet rebuilt, or in any other similar circumstances, subsequent Athletes must be halted.

In such a case, an Official should be posted in the path of the oncoming Athlete. The Official shall wave a red flag, which indicates that the Athlete must stop.

Failure to stop is penalised by elimination at the discretion of the Ground Jury.

The Official will stop Athletes only upon the instruction of the Control Centre or during an emergency at their own obstacle.

Athletes may be stopped on the course at obstacles or at designated timing/stopping points.

545.7.1 Timing

The time during which the Athlete was stopped, from the moment the Athlete passed the timing point until the Athlete passes that same point after being given the order to restart, will be recorded and it will be deducted from the total time taken by the Athlete to complete the course.

It is clearly intended that the time shall be taken as the Athlete gallops past the timing point, not after the Athlete halts nor after a start from the halt.

545.8 Leaving the Course After Elimination

An Athlete eliminated for any reason must leave the course at once and has no right to continue. The Athlete must walk their Horse off the course, either mounted or dismounted.

Athletes who fail to comply will be disciplined at the discretion of the Ground Jury in accordance with Art.525 (Dangerous Riding).

546 Courses

546.1 Marking

546.1.1 Red or White Boundary Flags

Red or white boundary flags shall be used to mark the starting and finishing lines, to mark compulsory passages, and to define obstacles. They are placed in such a way that an Athlete must leave a red flag on their right and a white flag on their left.

546.1.2 Numbers and Letters

Each obstacle on Cross Country shall be numbered. Obstacles with elements or options (art. 547.5.1) shall, in addition, be lettered (A, B, C, etc.). Each compulsory passage shall be marked and numbered consecutively.

546.1.3 Start and Finish Signs

In addition to the red or white boundary flags, the starting and finishing line shall also be marked by distinct signs.

546.2 Distances and Speeds

The distances and speeds demanded for the different levels are determined by the intended difficulty of the whole test.

Course Designers, within the limits shown in Table of Distances, Speeds, Times and Jumping Efforts for the relevant level of Competition see Annex B table Distances, will choose the most suitable distance for the specific Competition.

Any exceptional modification to the distances and speeds specified in Annex B table Distances must be approved by the Eventing Committee, except as provided for in Art. 537.2.

546.3 Finishing Lines

The last obstacle of Cross Country shall be not less than 20 metres no more than 50 metres from the finishing line.

546.4 Course Plans

Each Athlete will be given in advance a plan showing the track of the course.

The course plan must include the following:

- a) The position of the start and finish
- b) The numbered obstacles and compulsory passages
- c) The distance
- d) The optimum time and time limit

547 Obstacles

547.1 Definition

An obstacle is considered as such if and only if its extremities are marked with a red and white flag or flags and it is numbered and/or lettered accordingly. All significant jumping efforts that the average Horse may be expected to attempt to negotiate must be defined as an obstacle or element and flagged, numbered and/or lettered accordingly.

547.2 Type of Obstacles

547.2.1 General

The obstacles must be fixed and imposing in shape and appearance. When natural obstacles are

used, they should, if necessary, be reinforced so that they remain in the same state throughout the test. All reasonable precautions must be taken to prevent the possibility of an Athlete being able to pass mounted under an obstacle. Portable fences must be secured to the ground in a way that they have no possibility to move if hit by a Horse.

547.2.2 Construction

The obstacles at which a Horse, in falling, is likely to be trapped or to injure itself, must be built in such a way that part of the obstacle can be quickly dismantled and can be quickly rebuilt exactly as before. Such a construction must not in any way detract from the solidity of the obstacle.

547.2.3 Brush

Brush on top of fences must be made of flexible and deformable material. The fence must be constructed so that a Horse clearing the fixed and solid part is unlikely to be injured by the brush or hedge. Bullfinches, i.e. thin brushes or hedges through which a Horse can be expected to jump are permitted, provided they can be maintained in consistent condition throughout the test.

547.2.4 Frangible/Deformable Obstacles

Obstacles can be provided with frangible/deformable technology only if such technology has been approved by the FEI according to the FEI Standard for the minimum strength of frangible/deformable cross country fences. A list of approved technologies is published on the FEI website.

For all levels, all open oxers, open corners, verticals or near verticals with open rails, top rail on triple bars and gates where the rail dimensions and weight fit the acceptable parameters of an FEI approved frangible device, must be fitted with frangible devices.

547.2.5 Fences related to water

Each cross-country course must have at least one obstacle (effort) related to water

547.2.6 Sloping & Round Leading Edges

Spread fences including corners must not have an upright or vertical leading edge. The top of the front of the fence must be rounded or sloped. All other fences, including gates and fences using square and/or sawn materials, must not have any sharp or square edges. Brush fences are excluded provided there is at least 20cms of brush above the solid part of the fence.

547.2.7 Ground lines

Ground lines must be used on fences at all levels.

Note: Please refer to the Cross Country guide for Officials for further information about the use of Ground lines

547.3 Dimensions

The dimensions of obstacles must be within the limits shown in the Table of Obstacle Heights and Spreads for the relevant level of Competition see Annex B table Dimensions.

Obstacles must comply with the permitted fence dimensions as per Annex B at the time of the approval by the Ground Jury (in case of change of ground conditions).

547.3.1 Fixed Part

The fixed and solid part of an obstacle may not exceed the specified height or spread at any of the points at which an Athlete might reasonably attempt to negotiate the obstacle.

547.3.2 Brush

The overall height and the height of the solid part of a hedge or brush fence must never exceed the relative dimension set in the Table of Obstacle Heights and Spreads for the relevant level of Competition see Annex B table Dimensions.

547.3.3 Water

At obstacles involving water crossings (ford, lake or wide river), the depth of water, from the entrance to the exit must not exceed 35 centimetres. The length of any water crossing must be at least six meters between entry and exit, except where an exit step(s) or fence is jumped directly out of the water, in which case the minimum length must be nine meters.

A fence must not be less than two strides before a step out of water or three strides after a drop in water.

Water to water with a drop is not a permitted obstacle question at any level.

547.3.4 Obstacles with Spread Only

At an obstacle with spread only (dry or water filled ditch), a guard rail or hedge in front that facilitates jumping is permitted. It may not exceed 50 centimetres in height and must be included in the measurement of the spread.

547.3.5 Drops

At 2 star level, no drops over 160 centimetres are permitted. At 3, 4 & 5 star level drops with a flat landing exceeding 160 centimetres are limited to two.

547.4 Measurement

547.4.1 Height

The height of an obstacle is measured from the point where the average Horse would take off.

547.4.2 Spread

The spread of an open obstacle (e.g. oxer or ditch) is measured from the outside of the rails or other material making up the obstacle on the line where the average Horse is expected to jump. The spread of a closed obstacle with a solid top (e.g. Tables) is measured from the highest point to the highest point on the line where the average Horse is expected to jump.

547.4.3 Drop

The drop on the landing side of an obstacle is measured from the highest part of the obstacle, including from the top of a brush fence, to the point where the average Horse would land.

547.4.4 Natural Obstacles

When the height of an obstacle cannot be clearly defined (e.g. natural hedge, bullfinch), the height is measured to the solid part of the obstacle through which a Horse cannot pass with impunity.

547.5 Obstacles with Elements and/or Options

547.5.1 Obstacles Composed of Several Elements

If two or more jumping efforts, sited closely together, are designed as one integral test, they will be designated as "elements" of a single numbered obstacle. Each element will be marked with a different letter (A, B, C, etc.) and must be negotiated in the correct order.

Where two or more jumping efforts are sited so closely together that after a refusal or run-out it would be unreasonably difficult to attempt to negotiate the second or subsequent effort without retaking one or more earlier efforts, these jumping efforts must be designated as one numbered obstacle and lettered accordingly.

547.5.2 Obstacles with Alternatives

Where an obstacle may be jumped in one effort but has alternatives involving two or more efforts, each of these alternatives must be lettered or numbered as an element.

An alternative obstacle must be sited in such a way that the horse/ athlete must make a new attempt/approach after a refusal or run-out.

547.5.3 Black Flagged Alternatives

Alternative obstacles or elements may be flagged separately and must be identified by the same number/letter as on the direct route. In this case, both sets of flags must be marked with a black line.

547.6 Number of Jumping Efforts

The total number of jumping efforts shall be within the limits (minimum and maximum) shown in the Table of Distances, Speeds, Times and Jumping Efforts for the relevant level of Competition see Annex B table Distances.

The efforts to be counted are the efforts on the route expected to be taken by the average Horse.

For all classes at all levels it is possible to have a maximum of an additional 2 efforts whereby steps and ditches do not count as efforts under the following conditions:

- a) 2 steps as part of a combination/related fences only count as one effort, eg a sunken road with what would traditionally be 4 efforts (fence before, step down, step up, fence after) will count as 3 efforts
- b) 3 steps up or down will count as 2 efforts
- c) a ditch as part of a combination (e.g. a hollow/coffin type fence) does not count as an effort
- d) the steps and ditches would be flagged/lettered as normal and judged as normal. The CD and TD need to agree, in advance of the competition, how many of such efforts, if any, are appropriate for the particular competition given the nature of the terrain and the balance, flow, and intensity of the course

548 Scoring

548.1 Faults at Obstacles

Fault	Penalty
First refusal, run-out or circle	20 penalties
Second refusal, run-out or circle at the same obstacle	40 penalties
Third refusal, run-out or circle on XC Course	elimination
Fall of Athlete or Horse on Cross Country Course	elimination
Activating a frangible device where the dimension of the fence is modified	11 penalties
Dangerous Riding	25 penalties
Missing a flag as per art. 549.2	15 penalties

Evidence: Only official video recording can to be used as evidence. Officials will clarify before start of Cross Country and inform Chefs d'Equipe/riders at meeting/briefing which video recording will represent the official view, to avoid any misunderstanding.

548.2 Time Faults

Fault	Penalty
Exceeding optimum time	zero point four (0.4) penalty per commenced second
Exceeding time limit	elimination

548.3 Additional Reasons for Elimination

548.3.1 Compulsory Elimination

Elimination must be applied in the following cases:

- k) Competing with improper saddlery (art. 539).
- l) Error of course not rectified (art. 545.3).
- m) Omission of obstacle or compulsory passage (art. 545.3).
- n) Jumping or incurring a fault at an obstacle in the wrong order or passing through a compulsory passage in the wrong order (art. 545.3).
- o) Jumping an obstacle in the wrong direction (art. 545.3).
- p) Retaking an obstacle already jumped (art. 545.3).
- q) Athlete in difficulty (art. 545.6).

548.3.2 Ground Jury Discretion

Elimination is left to the discretion of the Ground Jury in the following cases:

- a) Dangerous riding (art. 525).
- b) Abuse of Horse (art. 526).
- c) Deliberately starting before being given the signal to start (art. 545.1.1).
- d) Jumping or attempting to jump any obstacle without headgear, or with an unfastened retention harness (art. 538.1.1).
- e) Wilful obstruction of an overtaking Athlete, or failure to follow the instructions of the Officials while being overtaken (art. 525).
- f) Causing danger to another Athlete while overtaking that Athlete (art. 525).
- g) Failure to stop when signalled (art. 545.7).
- h) Unauthorised assistance (art. 540).

549 Definition of Faults

The following faults at obstacles (refusal, run-out and circle) will be penalised unless, in the opinion of the relevant Official, they are clearly not connected with the negotiation or attempted negotiation of a numbered obstacle or element.

In the case of black flag alternatives only one obstacle/element has to be jumped and an Athlete is permitted to change without penalty from one black flagged line to another (e.g. jumping 6a left hand route then 6b right hand route) provided the Athlete has not presented their Horse at the next element of the original line.

In the case of black flags alternatives the faults at obstacles (refusal, run-out and circle) will only be penalised if related to the obstacle/elements attempted or negotiated (elements not attempted or negotiated will be irrelevant for the judging of such alternatives).

549.1 Refusal

549.1.1 Obstacles With Height

At obstacles or elements with height (i.e. exceeding 30 centimetres), a Horse is considered to have refused if it stops in front of the obstacle to be jumped.

549.1.2 Obstacles Without Height

At all other obstacles (i.e. 30 centimetres or less in height) a stop followed immediately by a standing jump is not however penalised, but if the halt is sustained or in any way prolonged, this constitutes a refusal. The Horse may step sideways but if it steps back, this is a refusal.

549.1.3 Multiple Refusals

After a refusal, if an Athlete redoubles or changes their efforts without success, or if the Horse

is represented at the obstacle after stepping back and stops or steps back again, this is a second refusal; and so on.

549.2 Run-out - missing a flag

a) Clear (0 penalties): A horse is considered to have cleared the fence when the head, neck and points of both shoulders pass between the extremities of the obstacle as flagged. If a flag is dislodged, the hindquarters must jump the height of the solid part of the obstacle.

b) Missing a flag (15 penalties): A horse is considered to have missed a flag when the point of a shoulder fails to pass between the extremities of the obstacle as flagged. The head and neck must pass inside the extremities of the obstacle as flagged. If a flag is dislodged, the hindquarters must jump the height of the solid part of the obstacle

c) Run-Out (20 penalties): A Horse is considered to have run-out if, having been presented at an obstacle on the course, it avoids it in such a way that the head, neck and point of either shoulder fail to pass between the extremities of the obstacle as flagged or the hindquarters have not jumped the height of the solid part of the obstacle. Continuing on course without representing will incur elimination.

549.2.1 Change of Intention

An Athlete is permitted to change their mind as to where the Athlete jumps an obstacle or element at any time, without penalty, including as a result of a mistake at a previous obstacle or element. If, however, the Horse avoids part of the obstacle at which it has been presented, the Combination will be considered to have run-out.

549.2.2 Judging of Bounce Obstacles

At any obstacle where the distance between elements is 5 meters or less (i.e. a "bounce"), when a Horse has negotiated the first element without penalty, the Horse will be deemed to have been presented at the second element and similarly if the "bounce" is for example the second and third elements of a combination. Thus if an Athlete "changes their mind" while negotiating the first element of a "bounce" and , for example, then goes a longer route, the Athlete will still be penalised 20 penalties for a run-out.

549.3 Circle

549.3.1 Separately Numbered Obstacles

At separately numbered obstacles, an Athlete may circle or cross their tracks between or around them without penalty provided the Athlete has not presented their Horse at the second or subsequent obstacles.

549.3.2 Obstacles Composed of Several Elements

At an obstacle composed of several elements (A, B, C, etc.) a Horse will be penalised once it has jumped the first element and before it has jumped the last element if:

- a) It passes around the back of any element of the lettered combination that it subsequently jumps.
- b) It crosses its tracks between the elements.
- c) It circles back around any element that it has already jumped before jumping any subsequent element of a lettered combination

549.4 Representing After a Disobedience

After being penalised for a refusal, run-out or circle, an Athlete, in order to make another attempt, is permitted to circle one or more times without penalty, until the Athlete again presents their Horse at the obstacle.

At an obstacle composed of several elements if the Athlete refuses, runs out or circles at any element, the Athlete is permitted to retake any elements already jumped, although the Athlete

is liable to be penalised for any fault even if the Athlete has previously jumped an element successfully.

If after a refusal, run-out or circle, the Athlete wishes to pass through flags in the wrong direction in order to retake an element, the Athlete may do so without penalty.

549.5 Fall

549.5.1 Athlete

An Athlete is considered to have fallen when the Athlete is separated from their Horse in such a way as to necessitate remounting.

549.5.2 Horse

A Horse is considered to have fallen when, at the same time, both its shoulder and quarters have touched either the ground or the obstacle and the ground or when it is trapped in a fence in such a way that it is unable to proceed without assistance or is liable to injure itself.

Chapter 10 JUMPING TEST

550 FEI Jumping Rules

The FEI Jumping Rules apply for the Eventing Jumping Test except where otherwise provided in these Eventing Rules. Any modification introduced to the FEI Jumping Rules during the year will be evaluated for inclusion in these Eventing Rules from 1st January the following year.

551 Object

This test is similar to an ordinary Jumping Competition, but without any attempt to find a winner of this test on its own. Its main objective is to prove that, the Horse and Athlete are well trained in the specialist discipline of Jumping.

The nature of the course, its length, the speed demanded and the dimensions of the obstacles will be in accordance to the level of the Competition.

552 Course and Obstacles

Within the limits shown in Jumping Annex C, the Course Designer is free to plan a track suitable to the level of the Competition.

The dimensions of the obstacles shall not exceed the limits shown in Jumping Annex C. At least two thirds shall be of maximum height for the level offered.

A tolerance of five centimetres in height is acceptable, if dictated by the terrain or by the spacing of the cups as authorised by the FEI Jumping Rules.

552.1 Type of Obstacles

The obstacles will be standard Jumping obstacles.

The obstacles should have a balance of vertical and spread obstacles and shall include two or three doubles or a double and a treble.

Closed combinations are not permitted. A water jump is not permitted, but a water ditch with rails over is allowed.

FEI approved safety cups must be used as support for back poles of spread obstacles, and in the case of a triple bar, to support the centre and back pole of the obstacle.

Alternative obstacles are permitted. These jumps are to be marked on the course plan with the same number and with the word "Alternative".

553 Scoring

553.1 Faults at Obstacles

Fault	Penalty
Knocking down an obstacle	4 penalties
First run-out, refusal or unauthorised circle in the whole test	4 penalties
Second run-out, refusal or unauthorised circle in the whole test	elimination
Fall of Athlete or Horse	elimination

553.2 Time Faults

The length of the course and the speed demanded determine the time allowed.

Completing the course in less than the time allowed is not rewarded, but exceeding the time allowed, Athletes are penalized with 0.4 penalty per commenced second.

Exceeding the time limit involves elimination.

Annexes

Annex A Dressage – Annexes

Note: For Eventing, the bits permitted for the Dressage test have been reformulated to take into account the wide use of snaffles in Eventing (different to the Dressage Rules) as well as defining the action.

Any approved mouthpiece may be combined with any approved cheek piece.

1 Permitted Bits for the Dressage Test

1.1 Action of Bits

- a) Snaffle bits work on the corners, tongue and bars of the mouth depending on their shape and the rein effect produced by the Athlete
- b) Single-jointed bits may also work on the roof of the mouth if not fitted and used correctly.
- c) Straight bar snaffles cause more tongue pressure
- d) Double-jointed snaffles conform to the shape of the mouth and tongue creating more even pressure
- e) Rounded or moving centrepieces encourage movement of the tongue and salivation
- f) Curved mouthpieces with joints and Mullen mouth bits conform to the shape of the tongue and mouth.
- g) Cheek Pieces
- h) Full cheek, egg butt and D ring snaffles are more stable and also work on the sides of the mouth
- i) Loose ring snaffles have a more moveable mouthpiece to encourage mouthing of the bit and salivation
- j) Hanging cheek snaffles have a slight leverage action and work more on the corners of the mouth and poll

1.2 Material:

- a) Durable enough to be safe
- b) Must keep smooth and solid surface, not to be altered by the chewing of the horse in order to prevent horse from injuries
- c) Not health-damaging
- d) Snaffles: can be made of metal, flexible rubber or synthetic, or plastic or leather material, and may be covered with rubber/latex or leather.
- e) Bridoon and curb: must be made of metal and/or rigid plastic and may be covered with rubber/latex.

1.3 Permitted Snaffles (see diagrams)

- a) May have one or two joints
- b) May be double-jointed with rounded or rotating mouthpiece allowing for better fit and comfort. The edges must be rounded and the length of the centre link must be 4.5cm long as a maximum.
- c) May have a slightly curved port, allowing more room for the tongue. The maximum height is 30mm from the lower part of the side of the tongue to the highest point of the deviation. The widest part of the deviation must be where the mouthpiece contacts the tongue and must have a minimum width of 30mm. The mouthpiece of a jointed or unjointed snaffle may be shaped in a curve within the dimensions specified above.
- d) Wavy bits are allowed









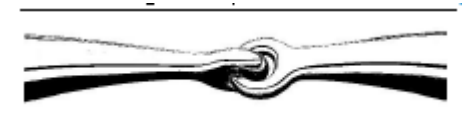

- e) A coupling is permitted as the centre link and must be solid with no moveable parts other than a roller.
- f) The centre link must be rounded
- g) The diameter of the mouthpiece must be a minimum of 14mm for Horses and 10mm for Ponies at the rings or cheeks.
- g)h) The maximum length of the cheek piece of a hanging cheek snaffle is 7cm measured from the top of the mouthpiece to the top of the small ring



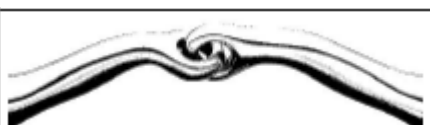



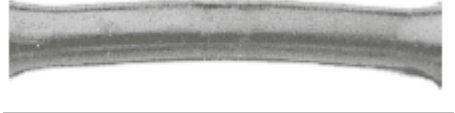

1.4 Illegal Bits

- a) Snaffles with a control plate (i.e Dr Bristol: if put incorrectly the edge of the plate causes excess pressure on tongue).
- b) Any single or double - jointed cable bits (may cause pinching of the tongue or cheeks)
- c) Bits which place mechanical restraint on tongue (large immovable centre link causes excessive pressure on tongue).
- d) Bits that can slide vertically creating a gag effect
- e) Mouthpiece wings that restrict the reins to move freely.





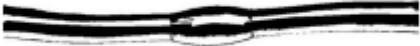



1.5 Snaffles



a) Permitted Mouthpieces

<p>1. Single-jointed</p> 	<p>10.</p> 
<p>2. Double-jointed</p> 	<p>11.</p> 
<p>3. Shaped single-jointed</p> 	<p>12.</p> 
<p>4. Single-jointed with rubber coating</p> 	<p>13.</p> 
<p>5. Double jointed with rotating middle-piece</p> 	<p>14.</p> 





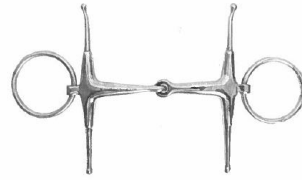

<p>6. Double jointed with plastic middle piece</p> 	<p>15.</p> 
<p>7. ball jointed</p> 	<p>16.</p> 
<p>8. multiple ball-jointed</p> 	<p>17.</p> 
<p>9. shaped double-jointed</p> 	<p>18.</p> 
	<p>19.</p> 



b) Permitted Cheek pieces:

<p>1. Loose Ring</p> 	<p>7. D-Ring</p> 
<p>2. Egg-Butt</p> 	<p>8. D-Ring</p> 
<p>3. Egg-Butt</p> 	<p>9. Loose ring with sleeves</p> 
<p>4. D-Ring</p> 	<p>10. Snaffle with full cheeks</p> 





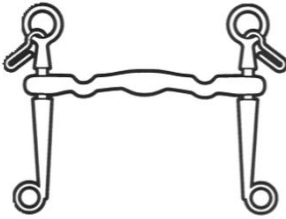

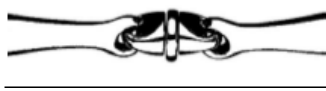

<p>5. D-Ring</p> 	<p>11. Snaffle with full cheeks</p> 
<p>6. Hanging-cheek</p> 	<p>12. Traditional snaffle cheek piece</p> 

1.6 Double Bridle





Permitted Curb Mouthpieces:	Permitted Curb Cheekpieces:
<p>1.</p> 	<p>1. Straight cheek</p> 
<p>2.</p> 	<p>2. Straight cheek</p> 
<p>3.</p> 	<p>3. S-Shape cheek</p> 

<p>4.</p> 	<p>4. Sliding Check Curb</p> 
<p>5.</p> 	

Permitted mouthpieces for Bridoon

<p>1. Single-jointed</p> 	<p>5. Souble-jointed with rotating middle-piece</p> 
<p>2. Double-jointed</p> 	<p>6. Double-jointed with plastic middle piece</p> 
<p>3. Shaped single-jointed</p> 	<p>7. Ball-jointed</p> 
<p>4. Single-jointed with rubber coating</p> 	<p>8. Multiple ball-jointed</p> 
	<p>9. Shaped double-jointed</p> 

Permitted Cheekpieces for Bridoon

<p>1. Loose Ring</p> 	<p>3. Egg-Butt</p> 
<p>2. Egg-Butt</p> 	<p>9. Loose ring with sleeves</p> 

2 Permitted Bridles for the Dressage Test

The images below are examples only, and similar bridles which produce the same effect on the horse are also allowed if they adhere to the art.539.

All Nosebands must be correctly fitted, and cannot be so tight to cause unnecessary discomfort to the Horse, ref. Code of Conduct.

1) Cavesson



2) Crossed noseband

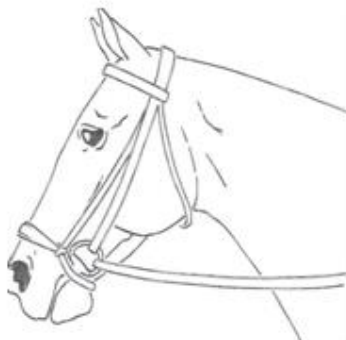
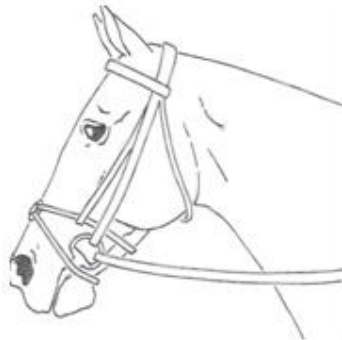

3) Dropped noseband



4) Flash noseband

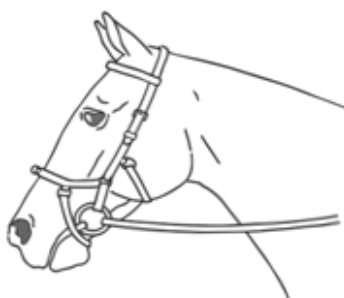

5) Micklem Bridle

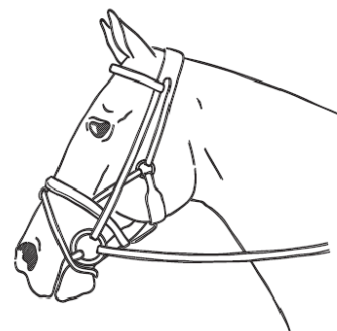

6) Stotztem (combined noseband – no throat lash)

Nosebands 2, 3, 4, 5 and 6 are not permitted when a double bridle is used

3 Dressage Tests for Eventing

Dressage Tests

Valid as from 1st January 2021

One star Competitions	1* Test	Approx. 4mn 30 sec
Two star Competitions	A 2* test	Approx. 4mn 45sec.
	B 2* test	Approx. 4mn 45sec.
Three star Competitions	A 3* test	Approx. 4mn 45sec.
	B 3* test	Approx. 4mn 45sec.
Four star Competitions	A 4* test	Approx. 4mn 45sec
	B 4* test	Approx. 4mn
Five star Competitions	A 5* test	Approx. 4mn 45sec
	B 5* test	Approx. 5 mn
Olympic Games	Olympic Games Short Test	Approx. 3 mn 30 sec
Pony CCIP1	CCIP1-L (<i>special Pony test</i>)	Approx. 5 mn 30sec
Pony CCIP2	B 2* Test (<i>regular B 2* test</i>)	Approx. 4mn 45 sec

In all Eventing Dressage Tests, the Collective Marks to be replaced by Harmony of Athletes and Horses describing a confident partnership created by adhering to the scale of training. .

Annex B Cross Country - Annexes

1 Cross Country Obstacles Maximum Dimensions

	One star	Two star	Three star	Four star	Five star	W-CH/ Olympic Games
Fixed (m.)	1.05 m	1.10 m	1.15 m	1.20 m	1.20 m	1.20 m
Brush (m.)	1.25 m	1.30 m	1.35 m	1.40 m	1.45 m	1.40 m
Top Spread (m.)	1.20 m	1.40 m	1.60 m	1.80 m	2.00 m	1.80 m
Base Spread (m.)	1.80 m	2.10 m	2.40 m	2.70 m	3.00 m	2.70 m
Without Height (m.)	2.40 m	2.80 m	3.20 m	3.60 m	4.00 m	3.60 m
Drop (m.)	1.40 m	1.60 m	1.80 m	2.00 m	2.00 m	2.00 m

2 Distances - Speeds - Jumping Efforts

CCI1*- Intro (unified)		
Distance (m.)	Min	2000
	Max	3000
Efforts	Min	20
	Max	25
Speed (m./min.)		500
Time (min.)	Min	4'00"
	Max	6'00"

CCI-S (Short) Cross Country Distances - Jumping Efforts - Speeds

Level		Two star	Three star	Four star
Distance (m.)	Min	2600	3025	3420
	Max	3120	3575	3990
Efforts	Min	25	27	30
	Max	30	32	35
Speed (m./min.)		520	550	570
Time (m.)	Min	5'00"	5'30"	6'00"
	Max	6'00"	6'30"	7'00"

CCI-L (Long) Cross Country Distances - Jumping Efforts - Speeds

Level		Two star	Three star	Four star	Five star	W-CH/Olympic Games
Distance (m.)	Min	3640	4400	5700	6270	5600 m
	Max	4680	5500	6270	6840	5800 m
Efforts	Min	25	30	35	40	38
	Max	30	35	40	45	42
Speed (m./min.)		520	550	570	570	570
Time (min.)	Min	7'00	8'00"	10'00"	11'00	9'50"
	Max	9'00	10'00"	11'00"	12'00	10'10"

~~CCI-S (Short) Cross Country Distances - Jumping Efforts - Speeds~~

Level		Two-star	Three-star	Four-star
Distance	Min	2600	3025	3420
	Max	3120	3575	3990
Efforts	Min	25	27	30
	Max	30	32	35
Speed		520	550	570
Time	Min	5'00"	5'30"	6'00"
	Max	6'00"	6'30"	7'00"

Within the above limits, the CD and TD may adjust in either direction to take account of the terrain, the number of efforts should be broadly proportional to the length of the course.

3 Diagram of Cross Country Obstacles and Faults

Explanatory diagrams can be found in a separate document published on FEI website, and is regularly updated.

Annex C Jumping - Annexes

1 Obstacles Maximum Dimensions - Distances - Speeds - Jumping Efforts

Maximum Dimensions - Distances - Speeds - Efforts

CCI - L & S	One star	Two star	Three star	Four star	Five star
Height (m.)	1.10	1.15 m	1.20 m	1.25 m	1.30 m
Oxer spread (m.)	1.25	1.35 m	1.40 m	1.45 m	1.45 m
Triple Bar spread (m.)	1.45	1.55 m	1.60 m	1.65 m	1.65 m
Distance (m.)	600 m	600 m	600 m	600 m	600 m
Speed	350 m	350 m	350 m	375 m	375 m
Nb Obstacles/ Max Efforts	10-11/12	10-11/13	10-11/14	11-12/15	11-13/16

If the arena is less than 5000 square meters, the maximum speed for Four & Five star level Competitions shall be 350 meters/min.

In arenas less than 2300 square meters the maximum speed for any level shall be 325/min.

Annex D Medical Services

Recommendations for Medical Services at FEI Competitions

Medical Services Coverage at FEI Competitions

This Annex outlines the medical service coverage to be implemented by Organising Committees (OCs) of FEI Eventing Events. It must be read in conjunction with the "Guidelines for the Medical Coverage at Events" available on the FEI website.

Note: This Annex is considered as recommendation for 2 years before mandatory implementation. Feedback from NFs and OCs from events in the next year will be reviewed by the Eventing and Medical Committee.

I. MEDICAL SERVICES REQUIREMENTS APPLICABLE THROUGHOUT THE EVENT

1. Chief Medical Officer (CMO)^(*)

1.1 Role

The CMO is appointed well in advance of the event and works closely with the Organizing Committee when planning for event medical coverage and participate in the preparation of the Serious Incident Management Plan (SIMP) for the event.

At Championships where, the CMO will arrange a meeting for the international team doctors and medical personnel in order to Familiarise them with the venue and available medical resources provide the necessary contact information to access the medical services.

1.2 Qualifications

The CMO does not have to be a physician, but is suitably experienced in the planning of medical coverage for equestrian events and has knowledge of the available local emergency medical resources and applicable local regulations.

2. First aid for spectators and workforce

First aid services for spectators and workforce must be provided in compliance with the locally applicable legislation and guidelines and following consultation with the CMO and local emergency medical service personnel.

3. On-site medical personnel

On-site medical personnel as detailed below must be available during the hours of competition and training periods.

They must be able to cover all riding and competition areas, stables, and on-site accommodations.

AVAILABILITY	MEDICAL PERSONNEL	NUMBERS	QUALIFICATIONS
Cross-Country test: at least 1(*)	Advanced Medical Response Team	At least: 2	At least: 1 member with the minimum necessary skills and experience to: <ol style="list-style-type: none"> i. perform advanced airway management, preferably with rapid sequence anaesthesia, intubation and rescue airway techniques; ii. decompress a tension pneumothorax; iii. insert intravenous and intraosseous lines to administer fluids and analgesia; and, iv. apply pelvic binders, cervical collars and place suitable splints for fractures; v) perform procedural sedation to allow rapid and humane limb reduction, splintage, extraction and transport.
Dressage, Jumping and Cross Country tests: At least 1	Standard Medical Response Teams	Minimum: 1 Ideally: 2	Training in immediate care and appropriate equipment for airway support, wound, bleeding and fracture management.
At all times	Ambulance or equivalent(**) for the transportation of injured or sick athletes to an appropriate treatment facility		<ul style="list-style-type: none"> - For events, ambulances should contain equipment for advanced airway support including oxygen, treatment of pneumothorax, intravenous access and fluids, management of cervical spine and other back injuries, long bone fractures. - The ambulance personnel must be adequately trained to use all such equipment.

Note: (*) These are new requirements.

()** Ambulances are medically equipped vehicles designed to transport an injured or sick patient to an appropriate medical treatment facility.

In countries where stationing ambulances at an event is not permitted by the law, a plan must be into place in order to enable a similar rapid evacuation service

4. Medical personnel access to the venue

All medical personnel with their emergency equipment and transport must have credentials and access to the entire venue at all times, including the stable area and finish during the competition.

They must be familiar prior to the competition with all access routes to the competition areas and anticipate alternatives in the event of inclement weather conditions which may necessitate the use of all-terrain vehicles for transport to ensure rapid evacuation.

Reliable radios must be available to ensure coordination with competition officials.

5. Radio & telephone communications

- Radio communications must be made available throughout the entire competition, to alert the on-site emergency medical providers

- A telephone line or cell phone must be reserved for immediate communication with the designated local emergency medical service and emergency hospital for additional needed resources or notification of transport from the event site.

II. MEDICAL SERVICES REQUIREMENTS APPLICABLE DURING COMPETITION TIME (INCLUDING DESIGNATED WARM-UP TIMES)

1. Medical response - DRESSAGE and JUMPING tests

MINIMUM REQUIREMENT		
Medical personnel type	Response time	Logistical considerations
1 x Standard Medical Response Team available on site	Strongly recommended: maximum 3 minutes ^(***) from notification of accident	Should have an immediate access to any part of the competition arena and warm up areas.
+		
Additional medical personnel required for adequate coverage		
As pre-determined by the CMO and OC depending on the layout and number of arenas		
+		
If possible: ambulance or equivalent arrangement (see table in II.3 for details) for:		
<ul style="list-style-type: none"> - Treatment of minor ailments - Observation and initial treatment of serious injuries or illness - Transportation to appropriate medical facilities. 		

2. Medical response – CROSS COUNTRY test

MINIMUM REQUIREMENT		
Medical personnel type	Response time	Logistical considerations
1 x Advanced Medical Response Team available at all times on site	Strongly recommended: maximum 5 minutes ^(***) from notification of accident	Capability of rapid deployment to any part of the course (including warm-up area) and all obstacles on the cross country course
+		
Additional medical personnel required for adequate coverage		
As pre- determined by the CMO depending on the layout of the Cross Country courses and the accessibility of the site.		
+		

If possible: ambulance or equivalent arrangement (see table in II.3 for details) for:

- Treatment of minor ailments
- Observation and initial treatment of serious injuries or illness
- Transportation to appropriate medical facilities.

Note: (***) The timing are new requirements.

3.1 Evacuation of injured athletes from the field of play

Provisions should be clearly established before the start of the competition for intermediate transport of any injured athletes off the field of play to the transport ambulance.

Possible adverse transport conditions due to weather conditions should be anticipated. This may include all wheel drive transport options which will require pre-positioning at the direction of the CMO and on-site medical providers.

3.2 Plan for the transportation of injured athletes to hospital

- In determining the number of ambulances, the CMO and OC should consider the distance to the nearest trauma hospital in case an ambulance has to leave the competition site, making sure that another appropriately equipped ambulance is still readily available to cover the competition. Otherwise the competition must be delayed until a replacement ambulance in on-site.
- Rapid routes for access and departure must be prepared in advance and safeguarded during the competition for the expeditious transfer of the seriously injured to an appropriate medical facility. This should also include pre-determined plans for access and egress for jumps that are deemed potentially high risk.
- Depending on the access to the site and the distance to a trauma hospital (greater than 60 minutes by land transport), helicopter evacuation should be strongly considered for seriously injured Athlete at the discretion of on-site medical personnel. A suitable landing zone should be identified and secured in advance for the medical evacuation helicopter. This information should be relayed by the CMO to the appropriate medical evacuation helicopter service in advance of the competition.

III. MANDATORY MEDICAL ASSESSMENT AFTER A FALL

If an Athlete falls at a Competition, the Athlete will not be allowed to continue without a medical assessment by on-site medical personnel, even if the Athlete has no obvious injury. Please see applicable FEI rules if an Athlete refuses medical evaluation which will result in immediate elimination for the remainder of the competition

Article 523.3 All Athletes that have had a fall during training on the Competition site or in Competition must be examined by the Official Medical Officer before they either take part in another test, Competition or leave the venue. The Athlete is fully responsible for ensuring that this examination takes place.

Article 527.1.d: Any Athlete who leaves the venue after a fall without submitting to the examination required under this Article will automatically be issued an Eventing Recorded Warning for incorrect behaviour, which will be delivered to their National Federation.

Annex E Organising Requirements for Eventing 5 star Level Events

Five star level Events are believed to be the pinnacle of the sport representing Eventing on the world stage and as such it is felt that there should be some guidelines for potential Organising Committees to ensure that the image of the sport and the presentation of the Event are of the highest possible quality.

The FEI will only recognise a few Events at this level and this recognition will be subject to some strict criteria.

Application process:

- a) Before being awarded an Event of five star level status the Organising Committee must have run, at the venue, a lower level international Eventing Competition of at least Four star level, and demonstrated the ability to stage an Event of the highest level.
- b) Application from the host National Federation to the FEI to stage a five star level Event must to be accompanied by a proposal including detailed information about the venue (access, facilities, etc) and the suitability of the footing, the Organising Committee, the financial viability (including proposed levels of sponsorship income), budget and cash-flow, local accommodation availability, and proposed level of prize money.
- c) The Organising Committee must have a proven track record of success. A business plan must be presented as well as a motivation letter on the reasons to transfer to the CCI5* category.
- d) Details in regard to the Organising Committees Broadcast strategy must be provided as well as expressions of interest in regard to Broadcast coverage and live streaming.
- e) The venue needs to be approved by an FEI appointed Delegate, who will visit the proposed Event at the OC's/National Federation's expense.
- f) The National Federation will be responsible for supporting the application and overseeing the success of the Event, and a representative of the National Federation must be included in the Board of the Organising Committee.
- g) The proposal must include the proposed Course Designer who must be an Eventing Level 3 Course Designer. The Course Designer in question must support the proposal and endorse that the venue is suitable for the Five star level.
- h) The Event has to be approved by the FEI Eventing Committee who reserve the right to ask for as much information as is considered necessary. The FEI Eventing Committee also reserves all rights to not accept the five star denomination request of any Organiser.
- i) Dates must fit in to the overall Eventing calendar, not clash with any major Event/Championship and be consistent from year to year in order to allow the other Events to position themselves in consequence.
- j) Applications shall be sent to the FEI at the latest by July the year preceding the Event applied for.

Requirements:

- k) Minimum level of prize money: €125'000 for 2020 and 2021, € 150'000 by 2022.
- l) Mandatory CCTV for public, Athletes, owners and the Ground Jury and for safety reasons.
- m) An all-weather dressage arena is strongly recommended.
- n) It is strongly encouraged that the OC appoints a Course Advisor, in consultation with the FEI and the Course Designer in charge.

Technical Standards:

- o) 5* Dressage and Show Jumping
11-12 minutes Cross Country / 6270-6840 m / 40-45 efforts

ANNEX E ORGANISING REQUIREMENTS FOR EVENTING 5 STAR LEVEL EVENTS - ANNEXES

5* Fence heights and fence technical standards

- p) Risk Management: the fall rate at 5*Events to be included in the evaluation (100%) to be set. Cross Country penalties rate if higher or lower than the set benchmark to be analysed with OC and Course Designer.
- q) Spectator & athlete experience: to be defined
- r) Organising Committee to appoint President of Ground Jury and Technical Delegate for 5 star events in consultation with the FEI.

Yearly Review:

- s) A review committee composed of representatives of the FEI Eventing Committee, FEI Delegate and the FEI Secretary General will assess existing five star level Events on a yearly basis. Should any Event not fulfil requirements it will be possible to re-evaluate the star level.
- t) Risk Management: Yearly review (fall rate) of all 5* Events to be conducted.
- u) All Events will be reviewed on yearly basis.

Annex F Athlete Representative

1 Appointment of Athlete Representative

Prior to the Athletes' first opportunity to inspect the Cross Country course every Organising Committee of an international Event must appoint an Athlete Representative from among the Athletes taking part in the Competition having first obtained that Athlete's consent.

This Athlete Representative has the task of acting as a channel of communication between the Athletes and the Officials on any matter directly connected with the Event without in any way removing the right of any Athlete to speak to the Organising Committee, Technical Delegate, Ground Jury, or Course Designer. The name of this Athlete must be notified to the Athletes at the briefing if one is held or posted prominently on the Event notice board if no briefing takes place.

2 Athletes Briefing

The usual Athletes briefing on routine matters to do with last minute changes due to meteorological conditions, ground, etc must still take place on the evening before the Cross Country Test.

Annex G FEI Badges for Honour

Badges of Honour will be awarded to Athletes who complete Olympic Games and World Championships to the following scale:

- h) A Gold Badge for three completions.
- i) A Silver Badge for two completions.
- j) A Bronze Badge for one completion.

Annex H Rules for Eventing Pony Rider & Events

Pony Rider Competitions are an important element in the development of equestrian sport in certain regions of the world. The Eventing Rules apply for the Eventing Pony Competitions except where otherwise provided in this annex. Pony rules have been integrated in the overall Eventing rules in regard to entries, participation, Officials appointment etc, according to the Long Format (CCI) 2 star Competition and championship.

1 International Pony Events and Qualification

1.1 Pony Competitions

Events limited to Pony competitors are designated with a "P" level 1 or 2: "L-Long" or "S-Short". These events are only reserved for pony riders according to age limitation.

- a) CCIP1 - Introductory level
- b) CCIP2 - Experienced level

The Pony European Championship will be held at the CCIP2 star level.

1.2 Qualifications

Pony Riders and ponies must be certified by their national federation as qualified to compete at the required level.

For Championships, Pony Riders and Ponies must have obtained as a combination a Minimum Eligibility result at a CCIP2-L or S, CCI2*-Long or Short.

2 Pony Measurement

Provisions in Veterinary Regulations apply.

3 Saddlery

Exercise Areas Article 539.1 applies except that hackamore, curb and double bridle are not allowed. Dressage Test " Article 539.2 applies except that curb and double bridle are not allowed (only snaffle bits). Cross-country and Jumping Tests - Article 539.3 applies except that curb, double bridle, hackamores and bit less bridle are not allowed. (See reference in FAQ Tack, Equipement and Dress on Eventing Rules page published on FEI Website).

- a) Pelham is allowed for XC and Jumping.
- b) A Pelham is not considered a Curb bit if it has a mouthpiece ring and a ring at the top and bottom of the bit.
- c) Pelham must be on a single rein (with a connecting piece from the mouthpiece ring to the bottom ring) – double reins not allowed.
- d) Pelham can be used with curb chain or leather strap.

4 Dressage Test

2014 CCIP1-L Test to apply for Eventing Dressage for Pony Events (CCIP1-L or S)

CCI2* B Test to apply for Eventing Dressage for Pony Events (CCIP2-L or S)

CCI2* B Test to apply for Eventing Dressage for Pony Championships

5 Cross-country Test

5.1 Types of Obstacles

- a) Bull finches are not allowed.
- b) Bounce fences (combination of upright obstacles with no stride) are allowed but must not be into water and must be of an appropriate distance, and degree of difficulty, for ponies and Pony Riders.
- c) The drop on the landing side of an obstacle, or of those obstacles that are jumped as a ski jump, may never exceed 1.45m. The number of such obstacles is limited to two. The number of drop fences less than 1.45m is left to the discretion of the Technical Delegate.

Table below to be replaced by the following:

Cross Country Obstacle – maximum - dimensions

	Pony P1	Pony P2
Fixed	1,00 m	1,05m
Brush	1,20m	1,25m
Top Spread	1,20m	1,30m
Base Spread	1,70m	1,90m
Without height	2,00m	2.50m
Drop	1,35m	1,45m

Cross Country Distances – Speeds – Jumping efforts (as per 2014 Rules)

Level	Distance		Efforts		Speed m/min		Meters/Effort	
	Min	Max	Min	Max	Min	Max	Min	Max
CCIP1	2300	3000	20	25	450	500	100	120
CCIP2	2700	3700	25	30	500	520	100	120

For Pony Championships the distance and speed should be the maximum allowed.

Jumping Obstacle Dimensions – Distances – Speed - Efforts

	CCIP1	CCIP2
Height	1,05m	1,10m
Oxer Spread	1,20m	1,25m
Triple Bar Spread	1,40m	1,50m
Distance	Max 500m	Max 500 m
Speed	350 m/min	350 m/min
Max Obstacles/efforts	10-11/13	10-11/14

Annex I Indoor / Arena Cross Country Rules

1 Rules for National and International competitions

FEI Rules apply to all Eventing Classes held within or in direct relation with, OR shortly before or after a FEI International Jumping/Dressage Event. The following minimum requirements are to be implemented by ALL Organising Committees organising this type of competition to manage and limit risk at these events.

NFs/OCs have two (2) options for the organisation of Indoor/Arena Eventing competitions:

1. Apply to the FEI to organise this class as an International competition with inclusion in the FEI Calendar using the competition code *CIX-Arena*. The competition schedule to be submitted to the FEI for approval (specific form available).

Or

2. Organise the competition under National rules under the responsibility of the National Federation to enforce the below compulsory minimum requirements.

The following minimum requirements are mandatory:

1. **Qualification of Athletes:** Competition open **only** to A, B and C FEI categorised Athletes (to ensure all Athletes have adequate experience)
2. **Qualification of Horses:** minimum 7 years old and having 1 MER in CCI-3* minimum
3. **Level of competition:** maximum (current) 3 star level obstacles with speed related to the size of the arena.
4. **Competition Format:**
 - Optimum time if competition runs over fixed obstacles
 - Against the clock: **ONLY** with knockable fences or hedges (min. 1/3 of the height of the obstacle)
 - Two phases:
 - 1st phase: fixed obstacles possible, Table A format not against the clock
 - 2nd phase: knockable fences, Table A against the clock
5. **FEI Officials:** One experienced FEI Eventing Course Designer or FEI Eventing Technical Delegate

2 Prizemoney & expenses

At the discretion of the Organising Committee, however the principle of this Competition is a demonstration class and should not be considered a high level Competition

3 The FEI Eventing Rules for Horse Welfare / Risk management

FEI Rules in regards to Dangerous Riding, sanctions etc, apply.

4 Promotion of Eventing as Discipline

Commentators: it is recommended that commentators with experience in Eventing are involved during the competition to explain Eventing, video clips are available for big screen to show the "real sport" (outdoor, 3 disciplines etc).

GLOSSARY

Competition:

As defined in the General Regulations, Competition refers to Refers to each individual class in which Athletes are placed in an order of merit and for which prizes may be awarded.

Cross Country Controller:

Is an experienced Official, who devises with the OC a communication plan for the Cross Country Test and organises the control of the Competition. Cross Country Controller liaises with the Ground Jury and Technical Delegate and advise of any situation development.

Elimination:

As defined in the General Regulations, Elimination means that an Athlete and/or a Horse may not continue in the Competition at issue and/or in any further Competition(s) of the Event, unless the Sport Rules provide otherwise.

Event:

As defined in the General Regulations, Event means a complete meeting, "Show", "Championship" or "Games". Events may be organised for one or more than one Discipline.

Disqualification:

As defined in the General Regulations, and unless the Sport Rules provide otherwise, Disqualification means that an Athlete and/or the Horse(s), is/are disqualified from the Competition at issue or from any further Competition(s) of the Event. Disqualification may also be retroactive.

Long Format Competitions:

Refer to Eventing Competitions that may take place over three or more days. The Dressage Test will be spread over one or more consecutive days, depending on the number of Athletes, directly followed on the next day by the Cross Country Test that will be directly followed on the next day by the Jumping Test. In the Long Format Competitions the Cross Country course will be of such a length that the Horse is required to be supremely fit and stamina will be required for success. The Cross Country Test will always take place before the Jumping Test.

Lower level event

Lower level event are defined as the competitions for 1* to 3* Competitions, long or short format, as specified in Appendix E of the FEI General Regulations

Minimum Eligibility Requirements (MER):

Refers to the prerequisites and conditions that need to be fulfilled by an Athlete to be allowed to compete at certain level of Eventing Competitions. A MER is achieved by completing an Eventing Competition within minimum parameters specified in the Eventing Rules.

Medical Information:

Athletes with medical conditions that may be relevant in the case of a medical emergency have the responsibility of wearing a medical data carrier from a system provider, able to communicate information at least in English at every Event when riding. Alternatively (and at the minimum) a medical armband of good quality can be used. Athletes who chose to wear an armband should download and fill the form available for this purpose on the FEI's website.

National Safety Officer:

Is a liaison between the NF and the FEI for obtaining the information regarding any international or national (including regional) Events. The National Safety Officer is responsible to spread FEI Eventing Risk Management vision and ideas (awareness) regarding the sport in the NF.

Short Format Competition:

Refer to Eventing Competitions that may take place over one or more days. The Dressage Test will always take place first and will be followed on the same or following days by the Jumping and Cross Country Test. In the Short Format Competition the level of difficulty of the Cross Country course is similar to the Long Format according to the star system, but the course is shorter and the intensity of efforts will be higher. The Cross Country Test will preferably take place after the Jumping Test.